

Maintenance/Repair/Replacement

Traditional Windows



Mark London
Dinu Bumbaru

HERITAGE MONTREAL

Technical guide 2

Produced in cooperation
with the Quebec Ministry of
Cultural Affairs

Traditional Windows

Mark London
Dinu Bumbaru

The English language
version of this guide was
translated and adapted with
the financial and technical
support of the Heritage
Canada Foundation.

Reprinted by permission of Héritage Montréal

HÉRITAGE MONTRÉAL

This technical guide is for owners of older buildings, property managers, architects, contractors and manufacturers. It applies to all kinds of pre-Second World War buildings, from simple homes to storefronts to office structures; it also mentions some specialized techniques which might only be used for particularly historic buildings.

This guide is divided into seven chapters. The first two contain general information on windows: components, functions, preservation principles, materials, and traditional window types. The next chapter deals with the inspection of a building's windows and how to evaluate which solution is required: maintenance, repair or replacement. Each of these options is the object of one of the next three chapters. The seventh and last chapter covers window accessories as well as other glazed structures such as skylights.

Dimensions in this guide are given first in feet and inches since most traditional windows were built using the Imperial system. They are generally followed by their metric equivalent.

Foreseeing further editions of this guide, readers' comments would be greatly appreciated.



Table of contents

Published by:
Heritage Montréal
406, Notre-Dame East
Montreal, Quebec,
H2Y 1C8
(514) 842-8678

Authors:
Mark London and Dinu Bumbaru

With the participation
of Pierre Beaupré (Société
du patrimoine urbain de
Montréal).

Translation: Héritage
Montréal

Acknowledgements:
François Leblanc, Martin
Weaver, Herb Stovel and
Meryl Oliver (The Heritage
Canada Foundation); Michael
Wells; Mireille Ostiguy;
Gilles Boivin (City of
Montreal, Housing
Restoration Dept.); Cécile
Baird; Joshua Wolfe; Noel
Meyer.

Produced in cooperation
with the Quebec Ministry of
Cultural Affairs.

The English language
version of this guide was
produced with the financial
and technical support of the
Heritage Canada Foundation
and The Samuel and Saydie
Bronfman Family Foundation.

ISBN: 2-920588-09-5
© 1985 Héritage Montréal

Printed in Canada

Introduction	3
Architectural traditions, 4	
<hr/>	
1. Uses and materials,	6
1.1 Terminology, 7	
1.2 Uses, 8	
1.3 Materials, 10	
<hr/>	
2. Types	16
2.1 History, 17	
2.2 Double-hung, 18	
2.3 Casement, 20	
2.4 Other types, 22	
<hr/>	
3. Inspection and evaluation	24
3.1 Inspection, 25	
Inspection table, 27	
3.2 Evaluation and decision, 28	
<hr/>	
4. Maintenance	30
4.1 General maintenance, 31	
4.2 Painting, 31	
<hr/>	
5. Repairs	34
5.1 Sills, 35	
5.2 Sashes, 36	
5.3 Mouldings and profiles, 37	
5.4 Muntins, 38	
5.5 Straightening the sash, 38	
5.6 Surface repair, 39	
5.7 Glazing, 40	
5.8 Hardware, 41	
5.9 Improving thermal efficiency, 42	
<hr/>	
6. Replacement	46
6.1 Aesthetic criteria, 47	
6.2 Technical criteria, 49	
<hr/>	
7. Accessories and special forms	52
7.1 Shutters, 53	
7.2 Awnings, 55	
7.3 Storm windows, 56	
7.4 Security, 60	
7.5 Skylights and dormer windows, 61	
7.6 Greenhouses and sunrooms, 62	
<hr/>	
Index	64
<hr/>	
Bibliography	64

Introduction



You can tell a lot about someone's character from their eyes. A strange squint, a "shifty" expression or other subtle nuances which would hardly be noticed elsewhere, really stand out with the eyes.

In the same way, windows in a building are major determinants of a building's character. Changes of just a few inches can throw the proportions of the whole facade out of balance.

Traditional windows had detail, intricacy and individual character. In some simple buildings, they are the only element which adds richness and delight.

Windows are the part of a building which tend to be most frequently changed. Usually, these changes are not only awkward but also needless.

It is usually possible to repair older windows. Rotted parts of the frame or sash can be repaired or replaced and glazing can be upgraded to improve energy efficiency.

However, since it is sometimes hard to find the necessary tradesmen, (and all too easy to find salesmen of new windows) replacement is often the only option even considered.

The purpose of this guide is to describe how traditional windows were designed and made, and to outline how they can be repaired and thermally upgraded.

It also describes aesthetic and technical criteria for choosing replacement windows, should this prove necessary.

Architectural traditions

Traditionally, architects conceived buildings based on a well-defined architectural vocabulary and solidly-established traditions. Builders copied classical designs from pattern books.

The smallest detail was important and contributed to the success of the building.

The architecture of a building generally reflected the time and place in which it was built. For example, house designs varied from:

- 18th century, French-Canadian farmhouses with stone walls, small-paned casement windows and steeply pitched roof, to
- 19th century row houses in Saint John's, Newfoundland with wooden sidings, medium-paned double-hung windows and flat roof with an ornate cornice, to
- early 20th century semi-detached town houses in Toronto with brick walls, larger double-hung windows and a pitched or false mansard roof covered in slate.

Today, buildings reflect the techniques and ideas of our era. They usually differ greatly from traditional models and there is much less regional variation than in pre-World War II building. For example:

- a 50-60's suburban bungalow with exterior walls covered in brick and artificial stone, with large picture windows, concrete front steps, and slightly sloped roof covered in asphalt shingles.

In their original form, traditional buildings invariably had a coherent architectural composition.

Since decades of demolition and questionable renovations have greatly reduced the stock of buildings constructed prior to the Second World War, those which retain their original design have a great cultural value, and this value is increasingly reflected in the real estate market.

Repairs and modifications to older buildings should respect the coherence of their composition and conserve their architectural integrity. Questionable changes harm the building's proportions and lessen both the historic and economic value of the building.

For example, replacing double-hung windows with picture windows transforms the building into a mish-mash of no particular date, neither traditional nor modern.

The character of a building

Deciding how to deal with a particular building element should depend not only on technical and economic factors. The architectural character and heritage value of the building and the element in question should also be taken into consideration.

In this guide, we will use the term heritage value in its broadest sense to refer to the architectural character and/or the historic value of a building.

The idea of heritage importance does not only apply to historic monuments and masterpieces. It also applies to simple buildings and neighbourhoods to which time has given a cultural importance.

The heritage value of a building depends on its history, its architecture and the way it fits into its surroundings. A few simple questions will help to evaluate its heritage importance. For example:

1. Does the building date from between the two wars, the turn of the century, the middle of the 19th century, or is it older?
2. Is it similar in style to other buildings in the neighbourhood?
3. Does it possess distinctive architectural elements?
4. Does it still have most of its original features? Are changes or additions in a traditional style?
5. Can inappropriate modifications be corrected?

For some buildings, further research should be done. Sources of more precise information are: architects and art historians, libraries and archives, and local historical societies and heritage groups.

Additional questions which could be asked are:

6. Is it an early or remarkable type of building, method of construction or architectural style?
7. Is it the work of a well-known architect or builder?
8. Was it the site of an historic event? Did important cultural, religious, social, political, economic, or industrial activities take place here?
9. Is it associated with an important individual or organization?

The greater the heritage value of a building, individually or as part of a group, the more important it becomes that each change respect its character.

Obviously, buildings of exceptional value demand meticulous restoration. But buildings which are not exceptionally important, but which have an interesting character and contribute to the quality of a neighbourhood, should not be unduly altered.

The character of an architectural element

The decision to save a particular building element, such as a window, should take into account its design and character, in relation to the value of the building as a whole. For example:

1. Is it a traditional window, perhaps the original?
2. Has the window been recently modified or replaced?
3. Does the window fit in well with the rest of the building?
4. Does the window have special characteristics in either its form or detail?

Again, it might be necessary to consult an expert to answer certain additional questions such as:

5. Is it representative of a particular style or of a regional architectural characteristic?
6. Is the window an important element in the building design or is it secondary to the richness of an ornate facade?
7. If the window has been changed, does this change correspond to a significant point in the evolution of the building (such as remodeling by an important person)?

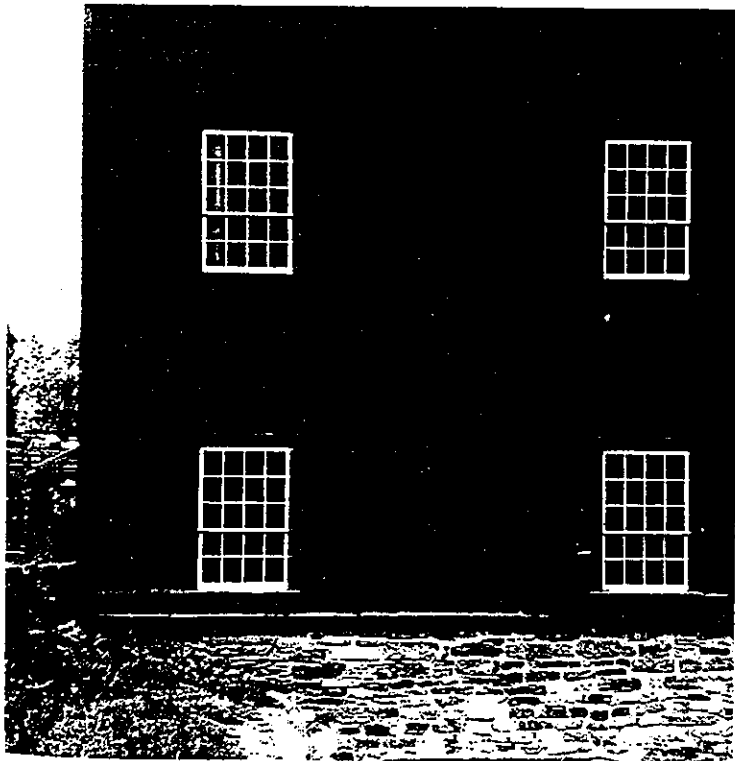

General approach

The more significant the building and the element in question, the more important it is to be especially careful when intervening.

In order to conserve the character of the building, it is desirable to:

- * Conserve architectural elements, avoiding, as much as possible, changing or replacing them;
- * Repair rather than replace damaged elements;
- * Replace with a new element which matches the original as much as possible if repair is not possible;
- * Avoid attempts to make the building look older than it really is;
- * Keep previous modifications which harmonize with the character of the building or reflect a significant stage in the evolution of the building;
- * Make changes in such a way that the original building is altered as little as possible and that the changes are reversible.

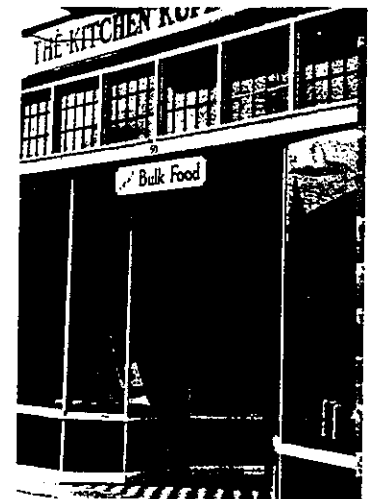

1. Uses and materials



A window is an opening in a wall, fitted with a frame containing glass.

Its practical **uses** (section 1.2) are to provide: **lighting and view outside, ventilation, protection from the elements, and conservation of heat.**

Windows also play an fundamental **aesthetic role** in the design of a building and every effort should be made to conserve specially designed or well-crafted, original windows, particularly windows which are in buildings of great architectural value. If windows must be replaced, reproductions of the originals are preferred.

The **material** (section 1.3) traditionally used for window frames and sashes was, of course, **wood**. One of the most commonly used species was white pine. Knowledge of how wood deteriorates and how it was worked in the past is useful in analyzing problems with windows.

The other key material, **glass**, was first hand-made using a variety of blowing techniques to produce crown and cylinder glass. The introduction of industrialized techniques late in the 19th century made it possible to produce much larger panes of glass and reduce the cost. A variety of special techniques continue to be used to make leaded (stained) glass and for other decorative windows.

Metal was originally used only for a window's hardware, but in this century came to be used for frames and sashes. The first metal windows were used on industrial and commercial buildings; today they are widely used in residential architecture.

Putty seals the glass into the frame. **Caulking** fills the gaps between the window frame and the wall.

Some kind of an exterior finish is essential to protect wood from the weather and the damaging, ultraviolet rays of the sun. **Paint** has long been the most commonly used protection although varnish was used for parts of the window subjected to friction. In recent years, stain has often been used instead of paint.

1.1. Terminology

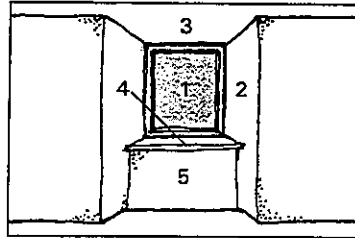

1. Parts of an embrasure:
1. Window opening
 2. Side wall
 3. Ceiling
 4. Extended sill
 5. Apron (or sill wall if the wall is the same thickness under sill)

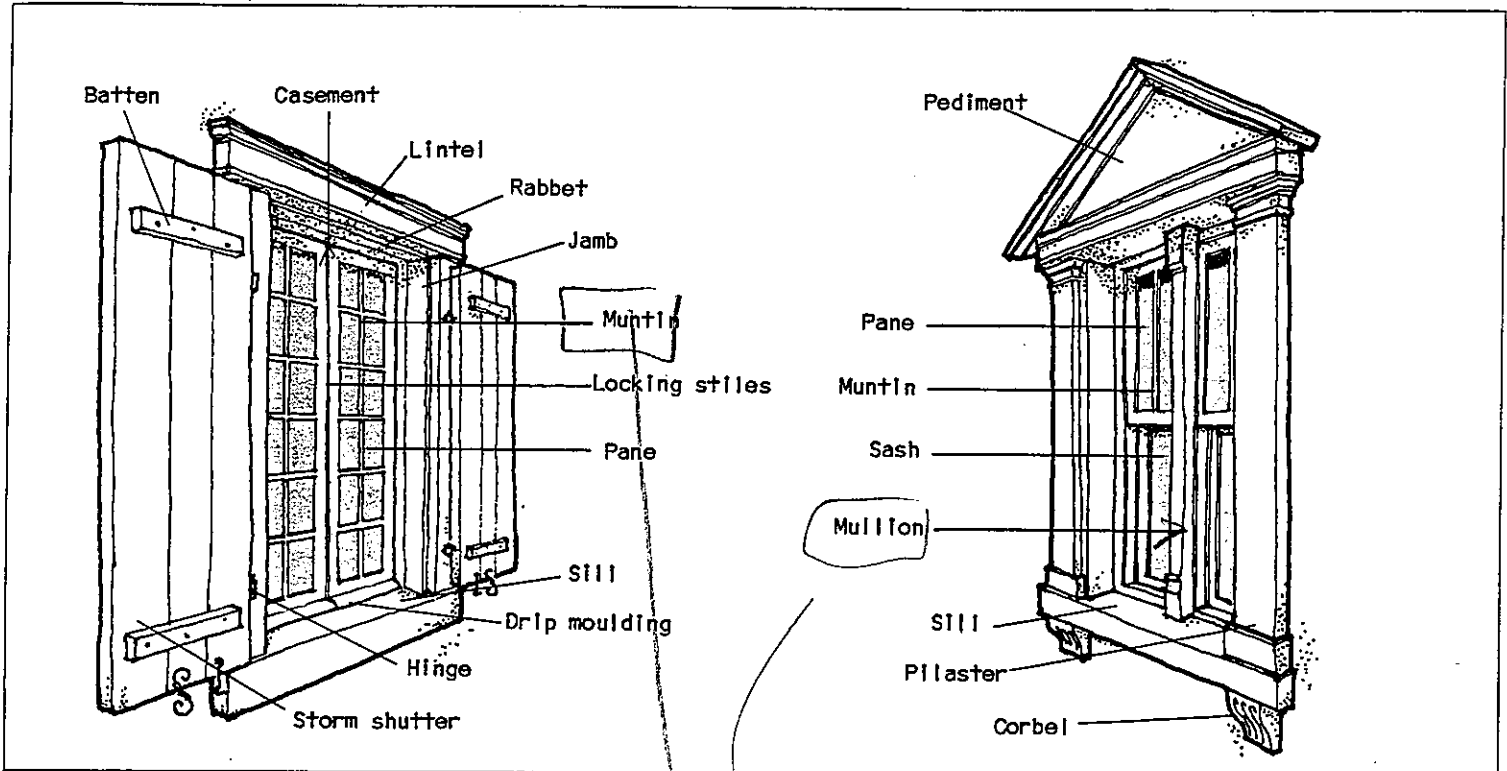

Apron: The trim member or the wall area under the projecting interior sill of a window.

Architrave: Either wood or stone mouldings surrounding doors or windows to conceal joints and for decorative purposes.

Bay window: A window that projects from the surface of an exterior wall and extends to the ground.

Came: Rod of soft metal used in leaded windows to hold together the panes of glass.

Casement: A window sash hinged on a vertical side.

Double-hung sash window: Two vertically hung sashes which slide up and down.

Drip moulding: Moulding on the bottom rail of a casement shedding the water away from the sash/sill joint.

Embrasure: An enlargement of a door or window opening, at the inside face of the wall, by means of splayed sides.

Flashing: Sheet of metal for weather-proofing (inserted under the siding and over the lintel of the window).

Frame: Fixed part of a window.

Jamb: Vertical part of the opening frame on which rests a lintel or an arch.

Light: Early term for pane.

Lintel: Upper horizontal member in wood, steel or stone which supports the load over the window opening.

Locking stiles: Vertical stiles in a casement window which join to close the window.

Meeting rails: Rails of the upper and lower sashes of a double-hung window that interlock when it is closed.

Mullion: Fixed post dividing multiple sashes.

Muntins: Small wood mouldings which bear the glass in a divided sash.

Pane: Relatively small sheet of glass framed in a window or a door.

Parting bead: A vertical guide strip set in the frame sides of a double-hung window separating the sash runs. Also called "parting strip".

Rabbet: Square groove usually provided for the storm windows.

Rail: Horizontal member of a sash.

Sash: Mobile or fixed frame which holds the glass.

Sash run: On a double-hung window, part of the frame sides where the sashes slide. Also called "slide".

Shutter: Solid or louvered panels used to close the window opening on the interior or exterior.

Sill: Horizontal surface at the bottom of a window opening.

Stile: Vertical member of a sash.

Stool: An inside sill of the window.

Stop: Vertical strip on the frame of a double-hung window on which slide the sashes.

Transom-bar: A horizontal member separating a transom window from a larger, lower window or door.

Transom window: A small window over a door or another window. Usually operable to allow ventilation.

Window opening: A hole in an exterior wall designed for a window and its frame.

1.2. Uses



Lighting and view outside

The degree to which a window lets light in and lets people see out depends not only on the size of the opening in the wall but also on the width of the frame and sash, the design and location of mullions, and to a lesser degree, on the type and transparency of the glass.

In order to ensure a sufficient level of natural lighting, building codes generally require that for most habitable rooms of a house (except bathrooms, halls and kitchens) windows with an area equal to at least 10% of the floor area of the room must be provided.

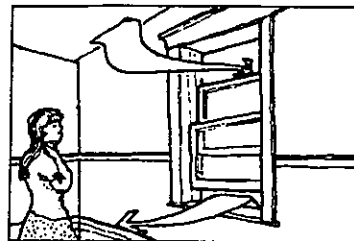

Ventilation

Building codes also ensure natural ventilation by regulating the openable area of windows in habitable rooms without mechanical ventilation. Generally, the requirement is that an openable area equal to at least 5% of the floor area be provided. If, as is often the case, the overall size of a window is the 10% legal minimum, then half of the window should be openable.

In the summertime, the aim is to maximize air movement. This can be done by ensuring that there are two opposed openings in a room or building which allow cross-ventilation. Older homes often had transoms over doors to allow ventilation when the door was shut.

Double-hung windows take advantage of small differences in pressure between warm and cool air to create a movement of air — in the bottom and out the top (in winter) and vice versa (in summer).

This same-air flow takes place on a larger scale within the whole building as hot air rises in chimneys, stairwells, skylights and atria, sucking cooler air in through other openings. To reduce air flow in the winter, windows should be air-tight, skylights and fans should be sealed, fireplace dampers closed (when not in use) and doors between rooms kept closed.

Screening allows ventilation while keeping bugs out. Louvered shutters allow ventilation while keeping out the sun's rays. Either can be installed on a permanent or seasonal basis.

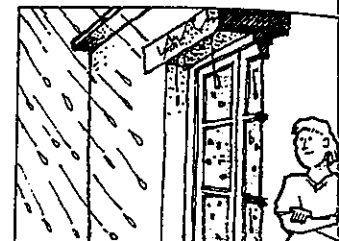

Protection against the elements

Raindrops will rarely penetrate through a closed window even if it is in relatively poor condition.

A more common cause of water penetration is poorly designed or deteriorated elements around the window such as cracked lintels or sills which tilt towards instead of away from the building.

The appearance of moisture inside the window is often caused by condensation. This will not only cause frost-covered windows in the winter, it can also result in rotting of the window as well as problems within the wall. Condensation can be prevented by ensuring that the inner window is well sealed so that moist inside air does not reach a cold surface where it would condense.

The space between the windows should be ventilated to the outside (with weepholes in the storm windows) so that any moisture which does find its way in (through condensation or the other causes mentioned above) can escape.

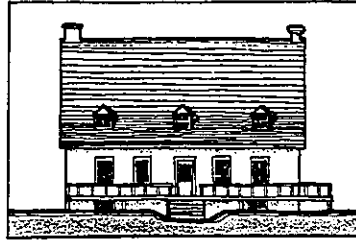
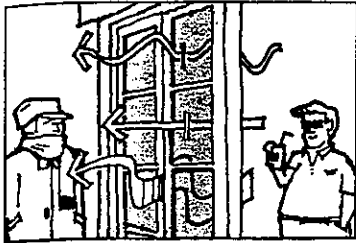

Conservation of heat

In a cold climate like Canada's, a primary role of a window is to conserve heat.

Windows are a critical factor in heat loss from a building. Poorly-fitted, single-pane windows can account for as much as 40% of total heat loss from an otherwise well-insulated building.

The principle cause of heat loss is infiltration: two cubic feet of air per minute can escape from each linear foot of crack (0.19m³/m/min). It can be reduced by improving the fit and installing weather-stripping.

The second way windows can allow heat loss is by conduction through the glass or frame. Conduction through the glass can be reduced by having a layer of trapped dead air (storm windows, sealed double windows, insulating shutters and shades).

Windows are also subject to heat loss or gain through radiation, for example, radiant energy from the sun directly heating the interior. Heat gain in the summer can be reduced through the use of awnings and shutters.

Aesthetic role

Windows are a basic element in the composition of a building facade.

The pattern of window openings in the facade are major determinants of its character. Traditionally, windows were relatively small, vertical openings. Although changing technology allowed larger windows, the vertical pattern remained dominant until very recently. Traditionally, square or horizontal openings were subdivided into a number of vertical windows.

The treatment of the wall around the window opening can vary from a simple frame to an elaborate starting point for a complex facade.

The detailed design of the window can also have an impact on the character of the building: the number and pattern of divisions, the width and profile of mullions and muntins, the depth of the window from the surface of the wall.

The important visual impact of the method of operation, can be seen by comparing three buildings with open, identically-sized windows, one of which is double-hung, the second casement and the third sliding. They look quite different.

If a window is to be repaired or replaced, its architectural role should be carefully evaluated.

It is particularly important to keep rare and ornate designs or hard to reproduce forms such as bent glass.

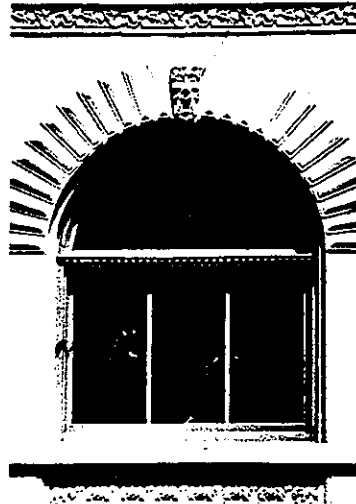

1.3. Materials

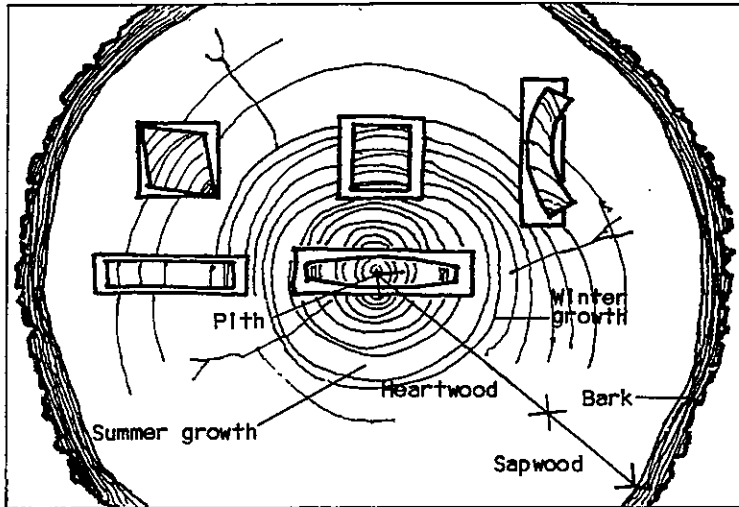

1. Section of a tree trunk: Depending on what part of the trunk the wood comes from, the direction of the grain will vary resulting in differences in the strength of parts of the piece, and how it deforms as it ages and dries.

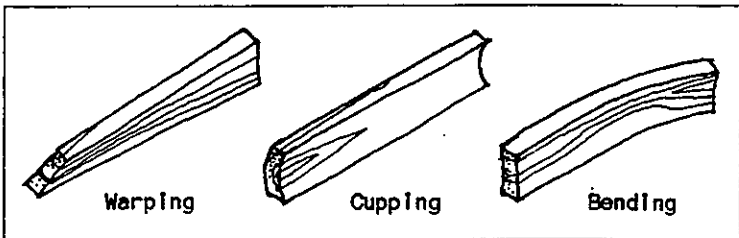

2. Various deformations resulting from changes in moisture content: If wood is improperly dried, or if it is improperly exposed to the weather and gets too damp, it will bend and warp. A surface protection on exterior wood (paint or stain) is essential to protect it from excessive moisture which can lead to these problems as well as rot.

Wood

Description: Wood used for making windows should come from the inner part of the tree which is harder and more water-resistant than the more porous outer growth layers (fig.1).

Since freshly cut wood contains a high percentage of water, it is milled and then dried (either in the open air or in a kiln) to a moisture level of less than 12%. Properly drying lumber helps prevent shrinkage, splitting and rot.

During the drying process, shrinkage can result; this follows the curve of the rings (fig.1). Warping can be the result of improper milling of the wood or improper drying which causes uneven shrinkage as a result of variations in the density, porosity or humidity levels of different parts of the wood.

Wood used in making windows (as with all exterior woodwork) should be protected from rot. Wood with a moisture level of more than 20% is especially susceptible.

Rot can be limited through the use of preservatives. The best current method is pressure-treatment in which milled lumber is subjected to a pressurized bath of preservatives. Next best method is simple soaking. Brushing on a preservative protects little more than the surface. The design of windows and other wooden elements should ensure that water and moisture do not accumulate which would bring the moisture content above the critical level.

The species of wood most commonly used in making traditional windows in Eastern Canada is white pine although jack pine and cedar are sometimes used.

Since white pine is relatively softer than other types of pine, it can be worked easily but is not structurally strong. It has a low level of shrinkage for a conifer. Since it contains little sap, white pine provides a good base for stain, varnish or paint. It holds nails or screws well. It is subject to damage because it is soft and light.

Cedar comes mainly from Western Canada although there are some Eastern species as well. It is very rot-resistant. Since it is quite soft, it can easily be damaged and does not hold nails or screws well.

Milling the lumber: The transformation of rough lumber into a material which could be used for making windows involved many operations. First the lumber was sawn into the approximate dimensions needed. Then it was planed. Finally the stock was shaped into profiles to produce decorative mouldings, an operation whose complexity depended on the complexity of the profile or moulding.

Before industrialization all of these tasks were performed with hand-held planes and routers. These tools can be described as knives or blades held in a wooden jig which steadied the cutting action. The knife in a plane could be raised to different angles depending on whether the plane was cutting soft or hard wood. A jointing plane, one used to level the surface of the wood, had a two-foot long bed which allowed it to run smoothly over the wood leaving a flat surface.

Once the wood was dressed, leveled and squared to the dimensions required, moulding planes were used to shape it. These planes had a profile cut into the blade. If the window was a simple one, only one profile would be cut. If it was very ornate, then a number of moulding planes with different profiles would be used. For sashes, two planes with different profiles would be bolted together. The joined planes had fixed guides which could be adjusted to fit standard dimensions.

Industrialization gradually put an end to the use of these tools. The first planers, which mechanically squared wood, appeared in England around 1793. Shapers, used to cut mouldings, became widespread between 1830 and 1860. Instead of mounting the cutting blades in a hand held tool, the blades were mounted on tables and automatically driven.

Mechanically produced mouldings can be recognized by undulations in the wood produced by the movement of the knives. This is not a sure method of checking because the wood might have been finished to eliminate the marks. Hand tools were generally used to fashion pre 1850 classic or renaissance details. The use of machines corresponds to the Victorian era when a larger variety of mouldings were produced in styles such as Gothic Revival and Romanesque.

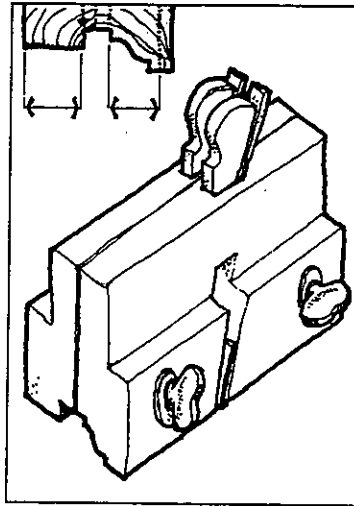

2. Sash plane: made of two planes joined together by wood screws.
Top left: detail indicating the position of two knives.

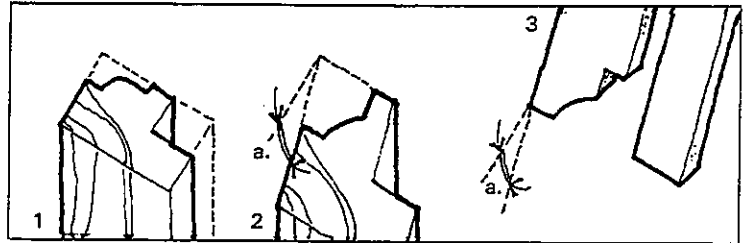

3. Making a moulding blade:

1. The profile was cut out from a block of wood;
2. The block was cut at the same angle as that of the blade in the plane (left).
3. The knife or knives are cut in the shape of the inclined face.

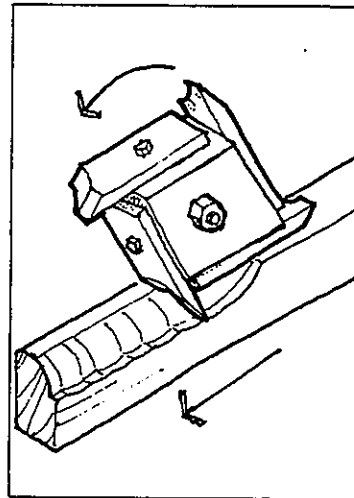
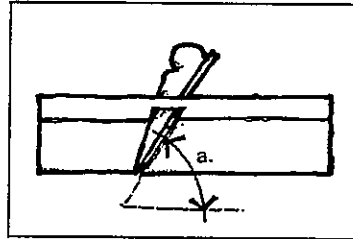

4. Moulding machine: this worked following the same principal as planes and jointers.

As with the router on the left, one can note the kind of marks left in the wood by different tools, marks which usually remain visible even after sanding.

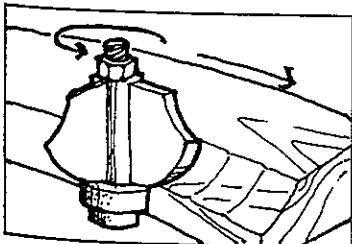

1. Table-mounted router: First used in the United States about 1853, the router was fixed and the piece of wood to be cut was moved.

7 A.D. - 2

Glass

History: Glass was discovered in the Middle East about 3000 B.C. and was long used solely for luxury objects. It was made by heating sand mixed with ash. Threads of molten glass were wrapped around clay balls to produce primitive bottles. Glass blowing was developed around 50 B.C. The Romans used glass for windows, but the material was crude, and its use primarily ornamental.

Early glass could not effectively be used for windows because of the green tint resulting from iron oxides in the sand. The Venetians bleached their glass which then became grey and, in thin layers, was almost transparent. Widespread use of this technique resulted in increased production and use of glass for windows but glass still remained a luxury item.

In Canada, waxed paper or animal skins had first been used to cover window openings. The use of glass in windows dates from the beginning of the 19th century. During the last century imported glass came mainly from England, some came from the United States and some high quality glass from Germany. Canadian glass production began between 1830 and 1850.

There were two traditional ways of making glass. Both procedures started by blowing the glass into a ball which produced a roughly uniform thickness. The two methods differed in how the glass was flattened.

The older method of making glass produced crown glass. It consisted of opening and turning the glass ball to make round discs four to five feet (1.2 to 1.5 m) in diameter. This resulted in concentric deformations as well as a thicker central part in the glass. This procedure was abandoned with the introduction of cylinder glass but came back into fashion for decorative purposes during the Victorian era.

The second technique was developed at the beginning of the 18th Century. Cylinder glass was manufactured by blowing the glass into a long cylinder, slitting it and flattening it on a table. This method produced elongated undulations in the glass. It was more fragile and less shiny

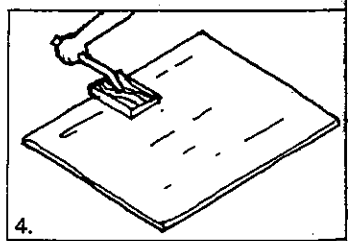
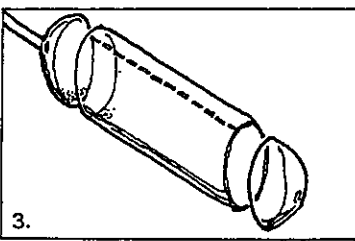
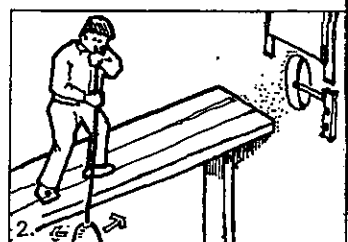
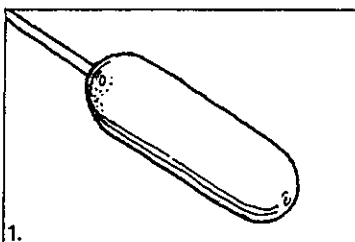
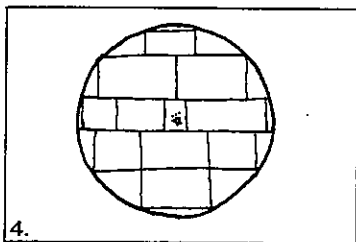
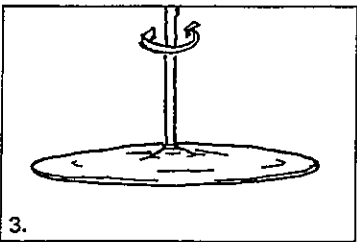
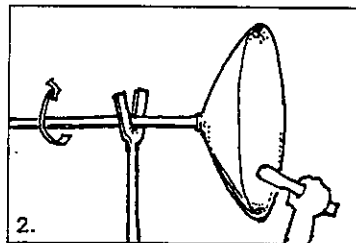
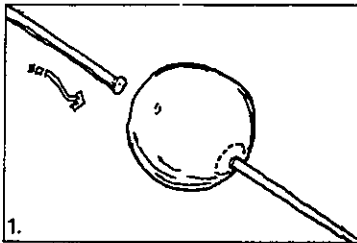

1. Making crown glass:

1. A mass of hot glass was first blown into a round ball. A new stem was attached to it and the blowing pipe was separated from it, thus creating an opening in the ball.
2. The glass was reheated and the edges of the opening were spread apart with an iron.

3. Spinning it flattened the glass by centrifugal force. The stem was removed and the glass reheated again.
4. This method produced discs of 4 to 5 feet (1.2 to 1.5m) in diameter.

2. Making cylinder glass:

1. As with crown glass, the first step was to blow molten glass into a ball.
2. Then, the blower stood on an elevated platform and swung the pipe while continuing to blow so that the ball was elongated.

3. The ball was reheated and the two ends were cut off by wrapping wire around them. The cylinder was then slit with a hot iron, and tempered in cold water.
4. It was reheated again placed on a stone table (with a flat glass surface) and flattened with a piece of wood.

than crown glass. Despite these drawbacks and the fact that making cylinder glass was still essentially a hand-made operation, this new method was more efficient and permitted making larger sheets of glass. It became the most widespread technique in the 19th Century in Canada and abroad.

Industrialized versions of this process made it possible to produce bigger glass cylinders (up to forty feet long [12m]) thus larger glass panes. This process was first developed in Europe in 1886 and came to North America around 1903.

A second method eliminated the operations necessary to flatten the cylinder. Molten glass was poured from a large basin directly onto the tables where it slowly cooled. This method was mainly developed since the beginning of the century.

Other specialized manufacturing techniques were also used in the 19th Century. Industrialized versions of traditional methods of blowing glass were used. During this period, plate glass was also produced. This was a superior product but because of its price, was limited for ornamental use (mirrors for example). To make plate glass, the molten glass was cast on a table, smoothed out, and polished when hardened. In levelling the glass with a hot roller, it was also possible to emboss designs into the glass which produced an effect similar to but less expensive than frosted or etched glass.

More recently, floating and tempering techniques have been developed. Floating consists of placing a sheet of glass over molten tin and letting it slowly reharden. This produces a surface similar to polished glass. Tempering glass consists of rapidly cooling a reheated sheet of glass. This increases its strength and resistance to breakage. Tempered glass is often identified with brand names in the glass and cannot be cut.

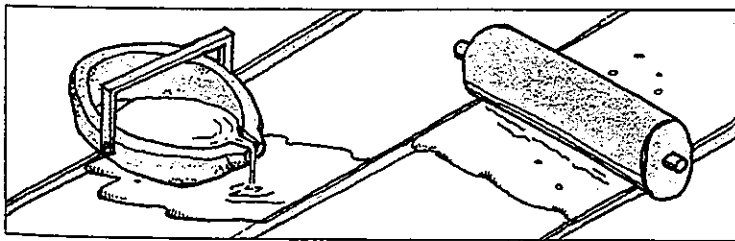

1. Making plate glass: Molten glass was poured over a metal or polished stone table divided by strips. A cast-iron roller leveled the glass after which it was polished.

Whereas glass made by other methods had a relatively irregular surface and curved or elongated bubbles in the glass, plate glass is characterized by its regularity and roundish bubbles.

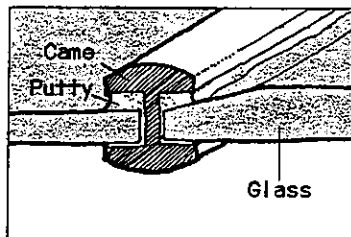

2. Joint in leaded glass

Special techniques

Coloured glass: A variety of specialized techniques are used in making glass for use in leaded (stained glass) windows. Coloured glass is made by adding oxides or other compounds to molten glass. Coloured glass can also be made by painting (with oxide compounds) onto clear glass and then baking.

Etched glass: There are two methods of etching glass. One is to cover the glass with a wax pattern and then use hydrofluoric acid to etch the unprotected area. The other method involves grinding the glass. In some techniques, the glass is supported with ropes to move it over a grinding tool.

Frosted glass: The two main traditional methods of manufacture were polishing the glass with abrasives (sand, grit or emery powder) rubbed onto the surface or placing hot glass on a sanded surface. More recently, glass is frosted by sandblasting or by exposing the glass to hydrofluoric acid fumes.



3. Making frosted glass: There were various techniques of producing frosted glass based on the use of special glues that contract when heated and crack off bits of the surface of the glass on which they were applied.

One of these techniques consisted of coating the glass with glue, and reheating it in an oven. This operation was repeated several times to achieve a textured surface. Glue was also applied to glass that had already been heated.

It is also possible to give glass a similar appearance without actually texturing it, by using special lacquers which frost while drying.

Metal

For centuries, metal was used only for two specialized purposes in windows: leading for stained glass and hardware.

Leaded (stained) glass consists of clear or coloured glass held together in I-shaped lead strips called cames. As early as the 6th Century, before the use of lead, coloured glass was held in place by wood, stone or marble. Early cames were cast one at a time; later they were extruded or laminated. Since pure lead is relatively soft, the practice was begun as early as the Middle Ages of reinforcing the lead with up to 30% tin.

Wrought iron was most commonly used for a window's hardware (nails, screws, hinges, hooks and bolts) although bronze was sometimes used for the more visible elements.

In the 19th century, industrialization brought about new methods of production which allowed profiles and mouldings to be cast in iron and bronze. Cast iron was moulded and then used for often elaborate window frames. At the turn of the century, windows were also made from sheet metal, galvanized steel was folded and assembled with screws to make windows and frames.

Metal windows were originally used only for industrial and then commercial buildings: factory windows, greenhouses, storefronts etc. During the 1930's steel windows appeared in domestic architecture. ~~Aluminum windows did not appear until after the Second World War.~~

Putty

Putty is an adhesive compound. Traditionally it has been made with white lead or powdered chalk mixed with a binding agent, generally double-boiled linseed oil. Putty hardens as the oil oxidizes, a process which can be accelerated by the presence of white lead or organic substances such as egg white.

There are now other synthetic compounds available for use as putty. Aluminum and steel windows generally require the use of special putties although traditional formulas are still generally used for cast iron or sheet metal sashes and frames.

Caulking

Caulking is used to seal gaps which inevitably exist between building elements, particularly between the window frame and wall. Since these gaps change in size with seasonal temperature changes or movement in the building, the caulking must be elastic. It must also adhere well to the surfaces on which it is being applied (some caulks adhere better to wood than to metal) and resist the effects of the sun's rays (ultraviolet radiation) and the effects of change in temperature.

If the gap is large, the opening is first filled with a substance which serves as a bed on which the caulking is applied. Traditionally, oakum (tarred hemp) was used although today it has been replaced with fibreglass or polystyrene foam.

When the caulking is going to be painted, it is important to choose a caulk and paint which are compatible.

Principal caulking products and their characteristics

Durability	Can be painted?	Use
1. Silicone		
20 years +	No	General
2. Polyurethane		
20 years +	Yes	General
3. Rubber butyl		
16 years	Yes	Masonry and metal
4. Latex		
5 years if painted	Yes	Not recommended for highly exposed locations. Better suited for the interior.

Paint

Paint is a material which, when applied to a surface as a liquid, hardens into a film as a result of evaporation or by means of chemical reactions with air or catalysts.

Paint is composed of pulverized pigment solids in a liquid base. There are two kinds of bases: oil-based or alkyd paints (made from either organic or synthetic oil or resin bases) and the more recently developed water-based paints (such as latex).

The base contains volatile spirits to make it fluid, as well as other components which harden with exposure to air and cement the pigments to the painted surface. Boiled linseed oil was traditionally used but has since been almost completely replaced by petroleum by-products.

Pigments are primarily used to solidify the various components in paint. Their secondary function is to act as a colouring agent, and for this purpose, special pigments are used. Pigments are chosen for four basic reasons: to stabilize, to mask and protect the surface underneath, to protect organic solvents from the sun, and to act as catalysts for the base.

Lead oxides or carbonates were commonly used as a base for paint. Although their use has been virtually eliminated because of their toxicity, they remain in use in some special paints and in colouring pigments.

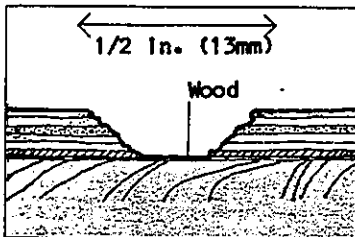

1. **Determining original paint colours:** On a part of the window which is not too visible, a small area is scraped and feather-sanded to reveal the various coats of paint down to the original. A magnifying glass makes it easier to see.

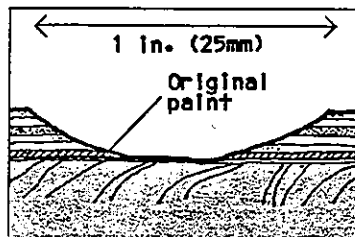

A more sophisticated method involves taking a paint chip and examining it under a low-power microscope (x10 or x20).

Types of paint and their characteristics

Alkyds: Alkyds, the name given to the majority of oil or resin-based paints, are used for both exterior and interior woodwork. They are resistant, flexible and adhere well to the surface. These paints continue to harden and contract long after they are applied and thus become weaker over time. In drying they release toxic odours.

Solvents: Mineral spirits and in certain cases water.

Latex: Either a synthetic emulsion or a natural latex base suspended in water, latexes are more stable than oil paints and can crack if applied over an alkyd base. In contrast to oil-based paints, latex paints dry rapidly without releasing toxic fumes.

Solvent: water

Varnish: A mixture of resins and drying oils, varnish is used for both interior and exterior work. It is also used in parts of windows subject to friction (sash runs of double-hung windows, meeting stiles of casement windows) because of its durability. (Urethanes also possess the same characteristics but have a greater water resistance.)

Since varnishes and shellacs (an alcohol solution of a resin) are transparent, they expose the wood to the ultraviolet rays of the sun which can lead to deterioration: therefore, they should only be used for interior work.

Solvents: turpentine, mineral spirits.

Stains: Stains are composed of small quantities of colouring pigments suspended in water, alcohol or oil. Unlike paint which forms a film on the surface of the wood, stain is much less viscous and penetrates into the wood.

Stains, used alone or before applying varnish or another transparent finish, bring out the grain and colour of the wood. They can be clear (not recommended for outdoor use), semi-transparent or opaque. Once available only in colours resembling various types of wood, they are now available in a wide variety of colours.

Their characteristics vary according to their composition, for example, water-based stains are generally more resistant than alcohol-based ones.

Solvents: Water and alcohol respectively are used as solvents for water-based and alcohol-based stains. Mineral spirits are used as solvents for oil-based stains.

2. Types

P. 712.

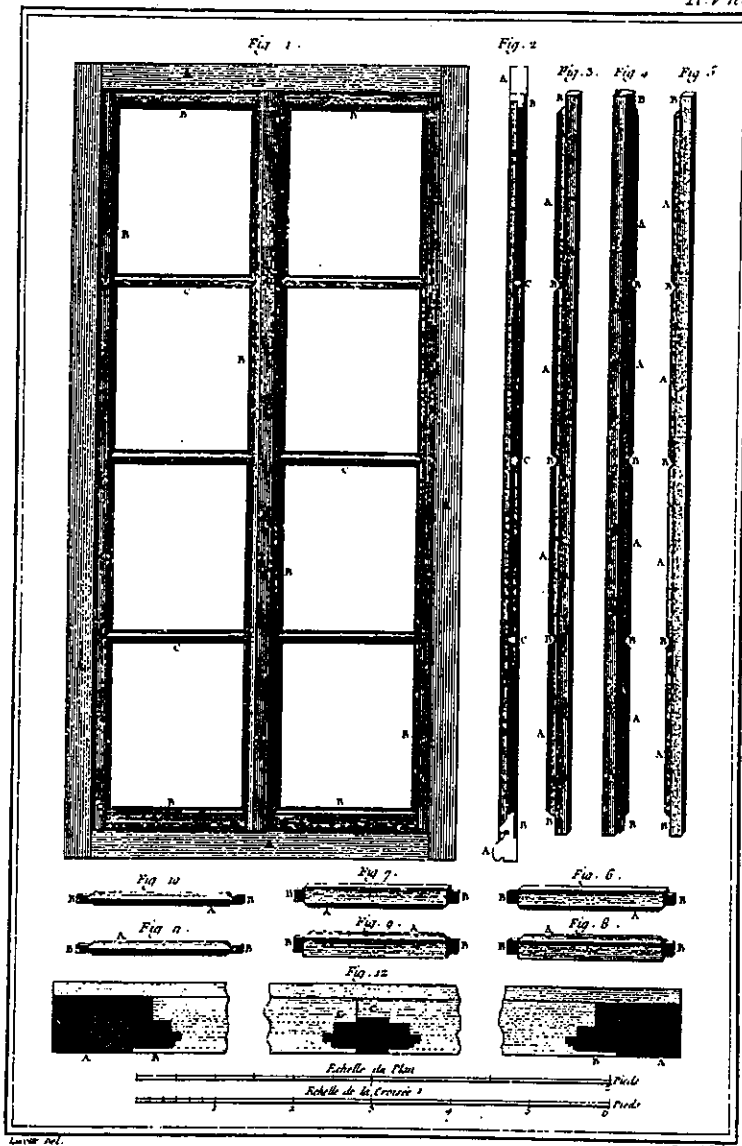

A look at the **history** (section 2.1) of windows in Canada shows that they evolved mainly as a result of technological change. This allowed the production of larger panes of glass and better methods of water and weather-proofing. There are also regional variations and changes in style.

However, from the beginning of European settlement in North America until the Second World War, virtually all windows were one of two types, based on how they open: double-hung and casement. The design of every part of the window except the glass (viz. frame, sash, hardware) is a direct result of the operating system.

Double-hung windows, (section 2.2) also called sash windows, consist of two vertically sliding sashes. They came to English Canada in the 18th century and by late 19th century even displaced "French" windows in Quebec.

Casement windows, (section 2.3) also called French windows, are composed of two wood frames called casements that are hinged on their vertical edges. Traditionally they opened to the interior. Used since the earliest days of the colony of New France, they were almost completely replaced between the mid 19th and mid 20th century by double-hung windows although they are now undergoing a revival, at least in Quebec.

Other types of windows such as fixed sash windows have long been used in domestic and public buildings. **Horizontally hinged windows** and **other types** such as pivoting and sliding windows were developed for industrial buildings and later came into general usage. **Combined windows** often used fixed sash with other types within one overall composition used one type as a storm window over another type.

2.1. History

The evolution of windows reflected changing taste and styles but was principally influenced by improvements in technology which resulted in larger windows, which operated more easily, were better insulated and were more water-tight. However, particularly in recent years, these changes were often to the detriment of the architectural character of windows and buildings.

In the earliest buildings of colonization in North America, windows were little more than small openings closed by waxed paper or animal skins and closed with a wooden shutter.

In New France, casement windows became widely used in both urban and rural settings. However, as new methods of construction reduced the thickness of walls, casement windows which formerly opened within the thickness of the wall (in an embrasure), now stuck into the room.

The double-hung (sash) window would resolve this problem in the 19th Century. Dutch and English in origin, its use became widespread in New England and Upper Canada. By the middle of the century, it was introduced in Quebec and though accepted slowly, not only became the standard for new construction by the end of the century, but even replaced many older casements on existing buildings.

In the 19th century, industrialization brought about many changes in window construction: window panes became larger, mouldings more refined, and higher quality hardware was used.

At the beginning of the century metal windows began to make their appearance. First used only in industrial architecture, by the 1930's they started to appear in commercial architecture and on public buildings.

After the Second World War, the use of double thermal glass and metal-covered wood began. The aluminum industry which grew to making war materials, switched to the manufacture of windows and flooded the market with aluminum windows which became the standard in suburban construction.

If a window must be replaced, it is generally best to replace it with the same kind. If the original window is missing, an understanding of the history and styles of windows in the region can give a good indication of what the original windows were like. The diagram to the right gives a simplified summary of how residential windows evolved (although regional variations can often be quite significant).

Evolution of window forms (In relation with doors)

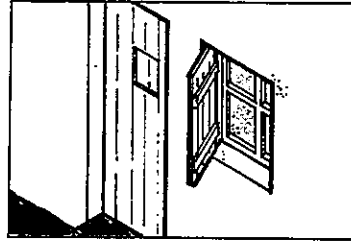

1. Pioneer cabin early days of colonization.

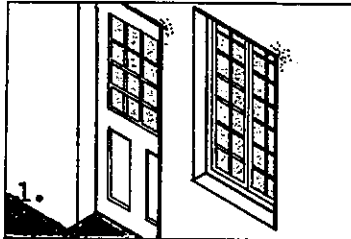

2. Early windows forms:
1. 17th and 18th centuries in Quebec.
2. 18th and 19th centuries in English Canada.



3. Mid-19th century.



4. Early 20th century.



5. Post-war, 1950.

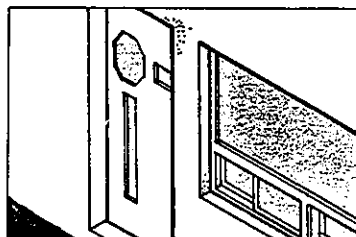

2.2. Double-hung

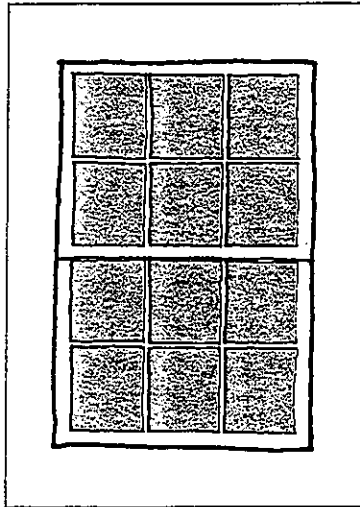

1. Some double-hung windows styles: Double-hung windows were brought to Canada from New England at the end of the 18th century.

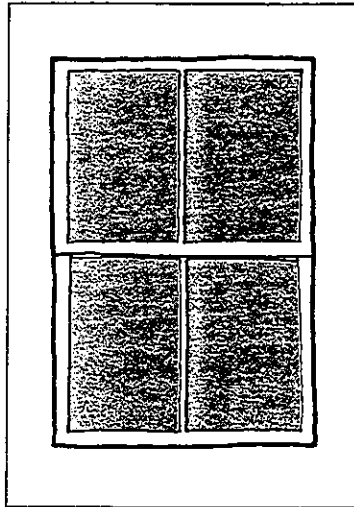

Sashes were first divided in small panes, because of the limited size of available glass. The number of panes varied according to the period and size and style of the window, the "six-over-six" (left) and "two-over-two" (right) being two common designs. The upper sash was sometimes bigger, for example producing "nine-over-six" windows.

The double-hung window (also called the sash window) is made up of two sashes which move vertically in slides called sash runs.

The sash runs are divided by a moulding called a parting bead placed in a groove between the two sashes. At both sides, interior and exterior, the sashes are held in place by mouldings called the stops.

When properly used, both the upper and lower sashes are opened. More often than not, the upper sash remains unused and becomes sealed with putty. Generally the interior sash controls the size of the opening. The lower rail of the upper sash and the upper rail of the lower sash interlock to limit air infiltration.

Several different mechanisms are used to decrease the weight of the sashes during their manipulations. The traditional method is a system of weights and pulleys. Generally made out of metal, sometimes the weights are made out of cast iron. A sash cord or metal chain is attached to the bottom of each sash. The cord is then run to a pulley at the top of the sash run. From there it is attached to a weight hung in a pocket or chute inside the window frame. The pocket is built into the frame of the wall before the window frame is constructed. Sometimes a wooden key separates two weights in the pocket. With smaller, lighter sashes there would be no weight and pulley system. Instead, notched pieces of wood were used to hold the window open.

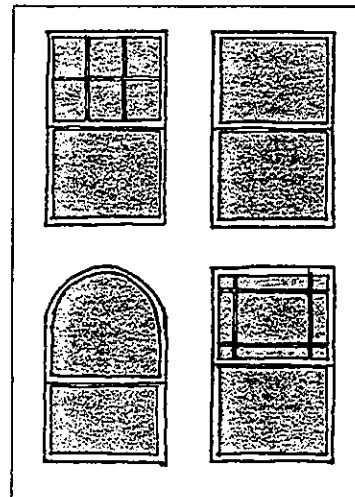

2. Other variations: The introduction of large size glass brought the elimination of many divisions. Often, the lower sash had a single pane.

During the Victorian era, the upper sash continued to have a variety of patterns of smaller panes, used for decorative purposes. At that time it became common to have curved upper sashes to fit within an arch.

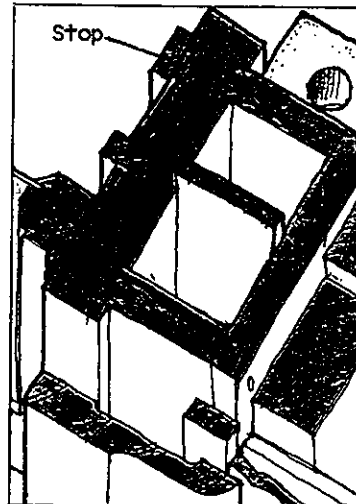
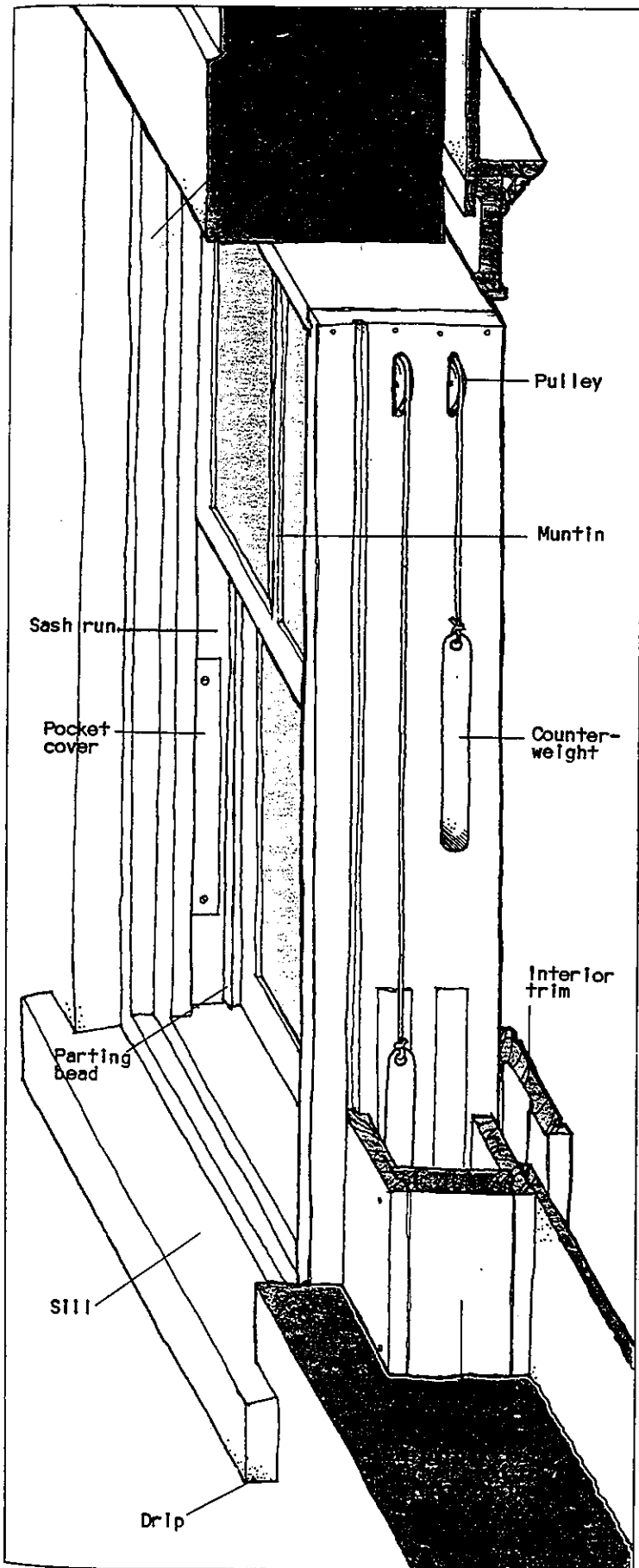

2. **Window frame and counterweight pocket:** The pieces of wood which form the pocket (chute) are nailed or inserted into a groove in the jamb; in the latter case, they are often screwed to facilitate the removal. Since these mouldings are rather thin, they rot quite rapidly if water infiltrates.

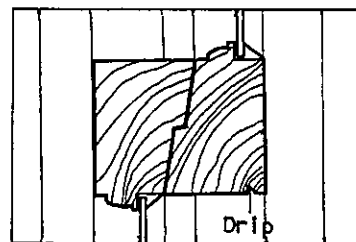

3. **Meeting rails:** The two sashes interlock to limit air infiltration. The lower rail of the exterior sash often has a groove (drip) which prevents the water from being drawn back onto the lower window by capillary and wind action.

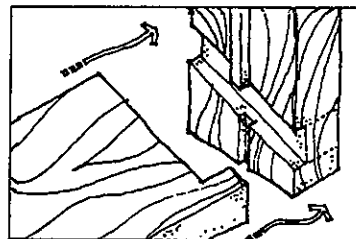

4. **Window-sill:** made of a piece of wood slid into a groove in the frame.

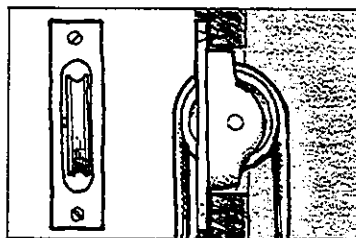

5. **Pulley:** Early pulley boxes were made from soldered sheet-iron; since the 19th century the pulley was either wood or cast-iron.

Sometimes, the wheel was able to rock in the frame when the sash was raised up.

2.3. Casement

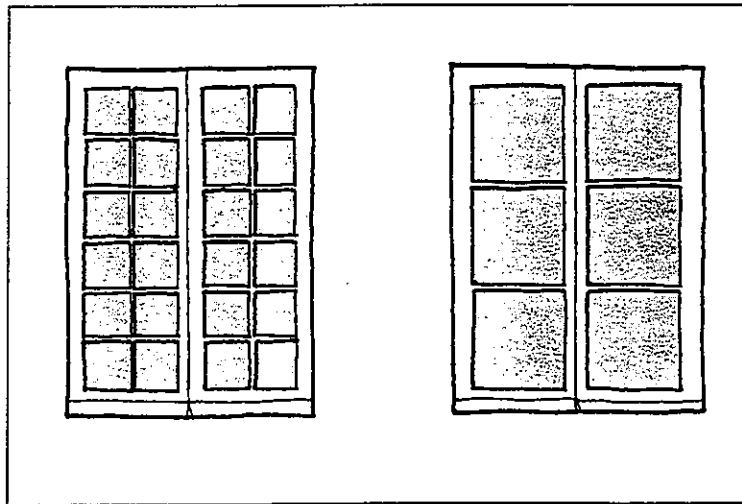

1. Two principal models of casement windows:
 * small panes
 * large panes

2. Example of casement windows at the beginning of the French colony (Samuel de Champlain's house).
 The window opening is divided in four parts each one closed by a casement. Similar window type was also used in New England.

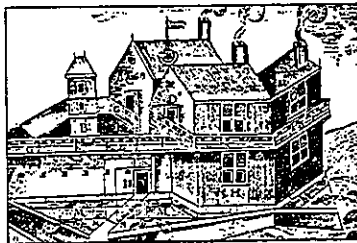

Casement windows (also called French windows) are made up of one or two sashes fixed vertically to the frame by hinges, generally opening to the interior. The number of sashes depends on the window's dimensions; traditionally only one sash was used if the opening was less than two and half feet (0.75m) wide. The sashes themselves are divided into panes by muntins, small wooden mouldings which form squares and support the glass.

The design of the joints where the stile and the two sashes met limited air and water infiltration. One kind used interlocking joints based on the tongue and grooved system (see page 21, fig. 2.2): it has the advantage of forming a very tight seal when closed. Another kind, a type of lap joint, allowed one casement to be opened while the other stayed closed (see page 22, fig. 2.3); although easier to use, the seal is not as good and it is more subject to deformation. The grooved joint is subject to warping. Both joints generally have a channel down the middle to allow moisture to escape.

At the bottom, the casement closed on a metal sill or, in some 19th century models, on a metal plate set in the sill. On the outside, a drip moulding on the bottom stile helped keep rain out.

The earliest casement windows had a large number of small panes, often 10 or 12 in a sash. In the 19th century, as improved manufacturing techniques and transportation made larger panes of glass available, sashes with only three or four panes became common.

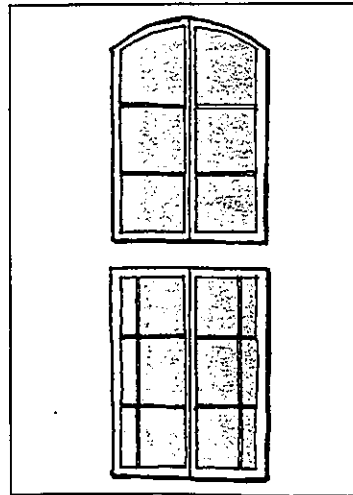

3. Other 19th century variations

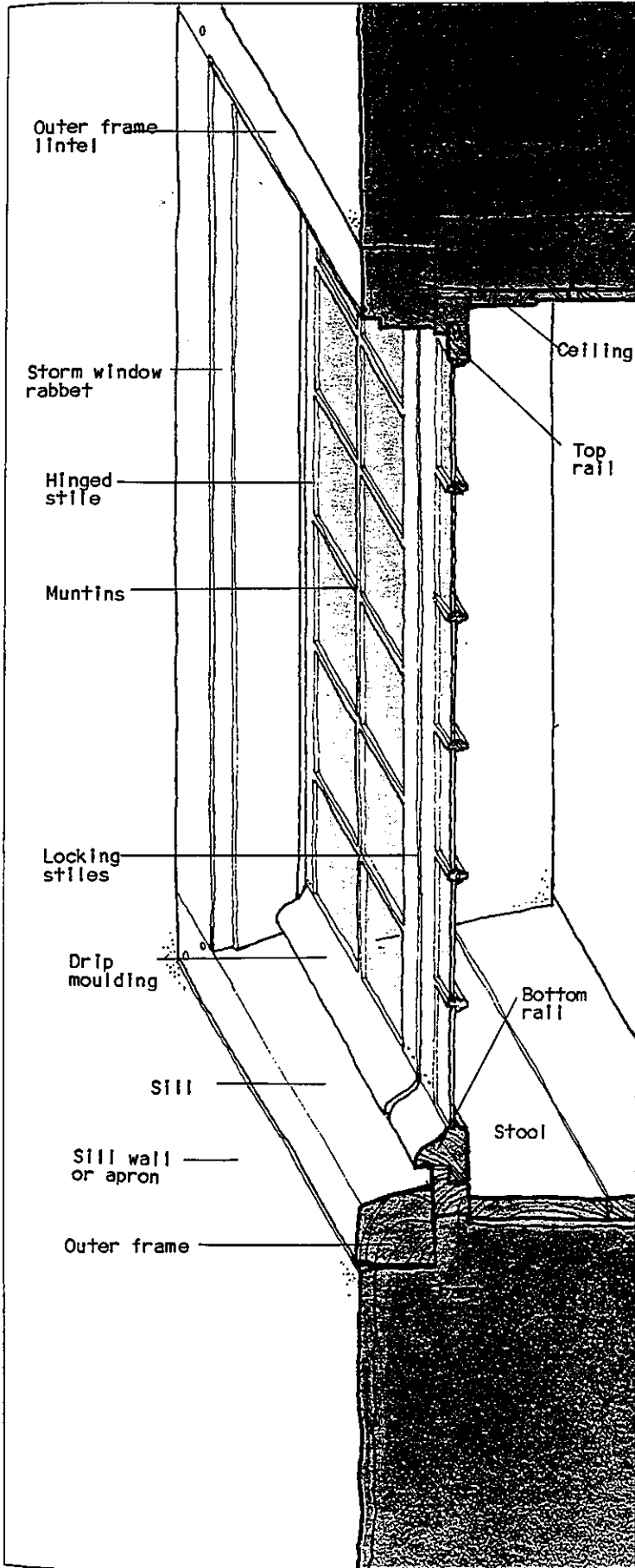

allows moisture to escape

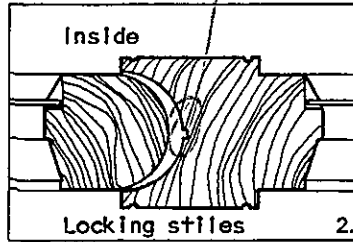
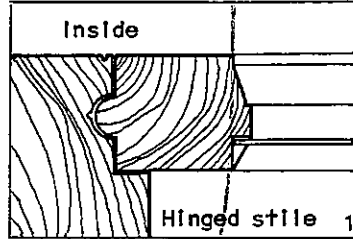

2. Profiles of casement stiles:
 1. Bead and groove
 2. Tongue and groove
 3. Lapping stiles

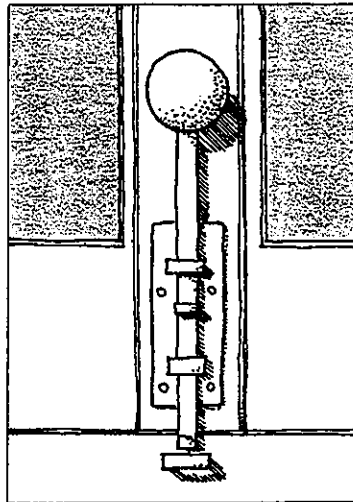
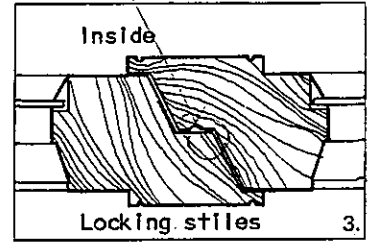

3. Window bolt:
 Traditionally made of wrought-iron; in important buildings and more recent models the handle was often made of copper or porcelain. There are usually two flat bolts, to lock the upper and lower parts of the casements; the upper bolt often has a longer stem.

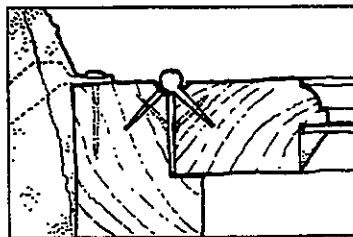

4. Hinge: Set into the sash and into the frame where it is held by nails.

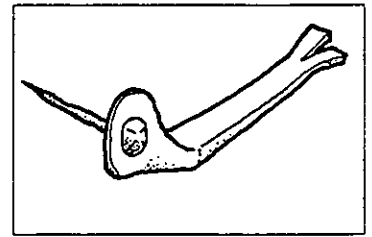

5. Sealing hook: Used to anchor the window frame into the wall.

2.4. Other types

Fixed sash windows

Some windows are used only to provide light to the interior of a building. Usually they are a single glass sash nailed into the frame or held in place by hooks or fly bolts. They can provide a certain amount of ventilation by having holes pierced through the sash.

The fixed sash is used mostly for uninhabited buildings, graineries and farm buildings, or for additional light where there are already enough moveable windows for ventilation purposes.

Fixed windows are often used as elements in architectural compositions. Since they do not need to open, they can be used to provide a greater variety of forms (round, arched etc.). They are often used in combination with other windows or doors. Stained, leaded, frosted, etched and stenciled glass are mainly used in fixed sashes as part of complex compositions.

Horizontally hinged sashes

Horizontally hinged sashes are called awning windows if hinged along the top rail and hopper windows if hinged along the bottom rail. A rod chain is used to hold them open.

This type of window was often used inside a building as a transom over a door. The use of this type of window on a building facade was generally limited to industrial and institutional buildings. It was rarely used on its own to fill a whole opening; usually it was used to provide ventilation in combination with other types of windows. They were often operated by means of cranks and sometimes gears.

By the end of the 19th century, these windows (often in metal) were very commonly used in industrial buildings, often in a form similar that illustrated on the opposite page, a small operable window set into a large grid of fixed sashes.

1. Fixed sashes around door: The doorway opening was often completed with a transom or leaded glass window above the door and sidelights beside the door.

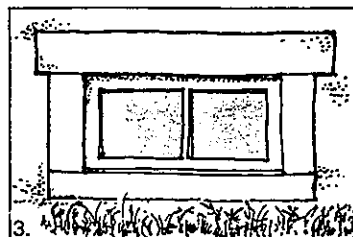
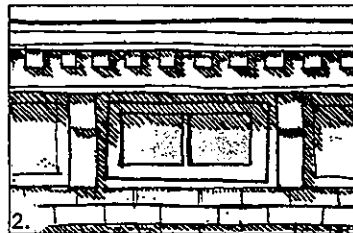
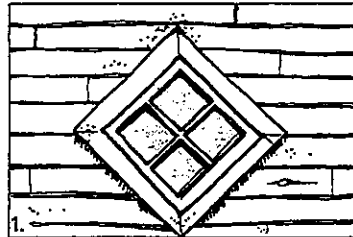
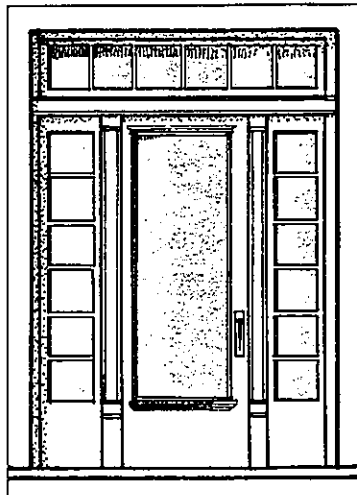

2. Different types of fixed sashes:

1. Gable window
2. Attic window in a cornice
3. Basement window



3. Hinged transom: division of the glazing follows the division between the two casements of the main window.

Other types of windows

Several other types of windows were used, often first in industrial buildings, to provide ventilation and allow maintenance.

Some of these windows are variations of the horizontally hinged sash. For example, horizontally pivoting sashes were used both as interior transoms and to provide ventilation in large industrial windows (vertically pivoting sashes were also used in the latter case).

On industrial and public buildings, these windows were usually made out of metal. In domestic architecture, they were often made out of wood.

Today, one of the most commonly used windows is the horizontally sliding window. Although isolated uses of this type occurred in the past, they are really a very modern innovation and before the fifties their use was almost exclusively in industrial and then commercial architecture.

Note that two other glass structures which play roles similar to windows (letting in light and protecting from the elements), namely greenhouses and skylights, are dealt with in the last chapter.

Combined models

From the basic window types described on the last few pages, designers, carpenters and manufacturers have come up with an almost unlimited number of combined models. They are basically of two types: several different types used to make one complex window, or the use of one type of window as the storm window for another (see pages 56-57).

Most often, fixed sashes were added to operable windows to increase the glass area without adding any moving parts. The mixture of window types was also used to create the desired architectural expression.

In combined windows, the fixed window was usually above or to the sides of the operable one.

The transom, on top of either a door or a window, is separated from them by a transom-bar. On the exterior, the transom is usually fixed in place by fly bolts but inside it is generally hinged or on a pivot so that it could be opened for ventilation. Fixed glass above operable windows was also used to close the curved or irregular portions of complex window openings.

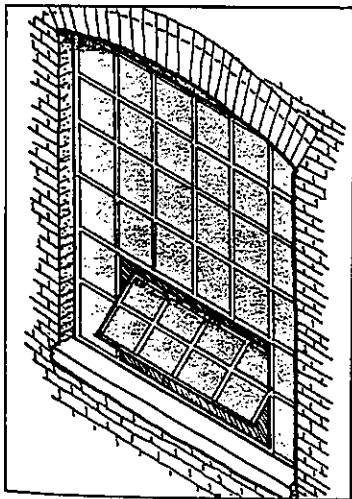

1. Pivoting industrial window integrated into the grid of fixed cast-iron windows.

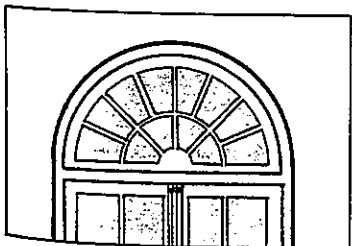

2. Arched transom above a casement window.

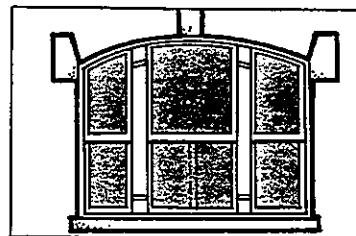

3. Typical combination window: There is almost an unlimited number of possible combinations of various window types. This example combines three double-hung windows, the middle one with a casement storm window on the inside of the lower sash and a fixed sash on the inside of the upper one while the side windows have second double-hung windows.

3. Inspection and evaluation



The question of what to do with the windows is a major part of any renovation. Both the final cost and look of the building depend on this decision.

The windows must be closely inspected to find out what work is necessary. When carrying out the **inspection** (Section 3.1) do not forget to take **safety precautions**.

The following questions should be asked: Does the window still operate well? Is the glazing sound? Is the drainage of rainwater and condensation adequate? Are the wood frames and sashes rotting, swelling or wearing out? Are the paint and hardware in good condition? Is the window energy efficient?

During the inspection, it should be determined whether there are problems caused by external conditions such as deformation of the building's shape due to structural problems or signs of water penetration such as cracks in or stains on the wall.

To help with the inspection, there is an **inspection table** on page 27 which lists most common window problems, what should be done to solve them, and where in the guide each topic is treated in detail.

The inspection is followed by an **evaluation** of the work to be done and the **final decision-making** (Section 3.2). Adopt a strategy with respect to the repairing or replacing of traditional windows should favour conservation of existing original windows (if at all possible), or replacement with an exact copy of the originals (if replacement is necessary).

This chapter gives some suggestions about where to find help in making the decision. Cost estimates for all options should be obtained. Repair may prove less expensive overall because even if some windows need major repair or even replacement, most of them usually need only minimal work.

3.1. Inspection

Safety precautions

Interior inspection is quite safe; however the use of gloves and safety glasses when removing old moulding is recommended to protect from flying splinters or flakes of paint.

For outdoor work, ladders and scaffolding should be well secured and checked for stability. Ladders should extend above the height of the windows. Inspection of the outside window can often be done from the inside by sitting or standing on a solid, dry window sill. It is important to be secured to the frame (not the sash which can move and cause loss of balance).

No work on ladders or scaffolding should be carried out on windy days. Wearing running shoes with good traction is advised. Amateurs should probably leave high altitude work to professionals who know what the risks are and how to cope with them.

The same precautions should be observed when performing maintenance, repair, or replacement.

Operation

Does the window open and close easily? With wooden windows this should be checked during various seasons to allow assessment of variations due to weather changes. Problems can stem from warped wood, defective hardware or operating mechanisms and paint accumulation in grooves and slides.

With double-hung windows, the sashes should be moved up and down to check the amount of friction and to see whether the counterweights effectively keep the window open at various heights.

Glazing

Besides checking for broken glass, the condition of the putty should be examined. It could be dry, cracked or have completely fallen out, leaving the wood unprotected and liable to rot.

Drainage of rainwater and condensation

It is useful to look for these problems from the interior during a rainstorm in order to locate any water accumulation or infiltration.

Ensure that the window sill slopes away from the wall at an angle of at least 10° to 15° and that it, as well as other parts of the frame and lintel, are sealed and water tight. However, it is equally important to ensure that paint, caulking, weather-stripping or new storm windows do not interfere with water drainage.

Wood frame and sash

Rot: Exposed end grain is the most susceptible to rot. The bottom of jambs, rails and sills are all vulnerable. Flaking or chipping paint can indicate places where moisture is retained in the wood.

To check for rot, push an ice pick, knife, or screwdriver into the wood. If the wood is rotten, the point will go in easily for at least 1/2 inch (1 cm) and the wood will feel mushy. Check all the joints in the window components, as well as screens and shutters.

Swelling and warping: Swelling and warping are caused by variations in the humidity level. When this occurs, windows become difficult to open. Swelling and warping are more often associated with changing weather or the state of the caulking than to the actual construction of the window. For easy opening, the window should slide but not be too loose. Remember that what swells in the humidity of summer will shrink in the dryness of winter.

Wear and tear: Sash runs and moving parts should be examined for wear caused by friction. One should also look for surface deterioration, such as cracks or checks in the wood.

Paint

Exterior paint should be examined every two years. Surfaces that are painted (wood, hardware and putty) should be inspected for their ability to protect as much as for their appearance. The condition of the paint will reveal the kind of work that needs to be carried out. Bubbling paint might indicate rust or rot; accumulated paint in sash runs and grooves means that the window will no longer function as easily as it should.

Hardware

With double-hung windows, check weights and pulleys and their connecting mechanisms (cords or chains). The hinges on casement windows should be checked for rust and alignment. If the hinges have come loose or moved, they can cause the windows to bind. See if the screws or nails that hold the hinges and closing mechanisms in place are secure.

Check the hooks, fly nuts, and hinges on double windows, screens and shutters.

Evaluating energy efficiency

Materials: Glazing occupies the largest space in a window and it should be well examined. Check for the number of panes, their thickness, and the tightness of the caulking and putty.

Air Infiltration: Look for air infiltration when the wind is blowing. Close the window, then pass a flame (a lighter or burning paper) or feel around the joints and interior mouldings. This will check the tightness of both the window and the exterior frame caulking. Rattling sashes on a windy day is also an indication of air infiltration.

Check for paint build-up between the frame and sash wherever two pieces of wood come into contact or butt up against each other. Pay attention to slide stops, grooves and jambs. Too much paint can cause bad closing of the joint and binding. Check the weather-stripping (mouldings, spring metal or felt) for their effectiveness.

In double-hung windows, paint accumulation can make it difficult for the window to move. In casement windows, inspect the closing joinery (the interlocking mouldings between sashes and frame).

Inspect integrated storm windows, aluminum shutters and screens.

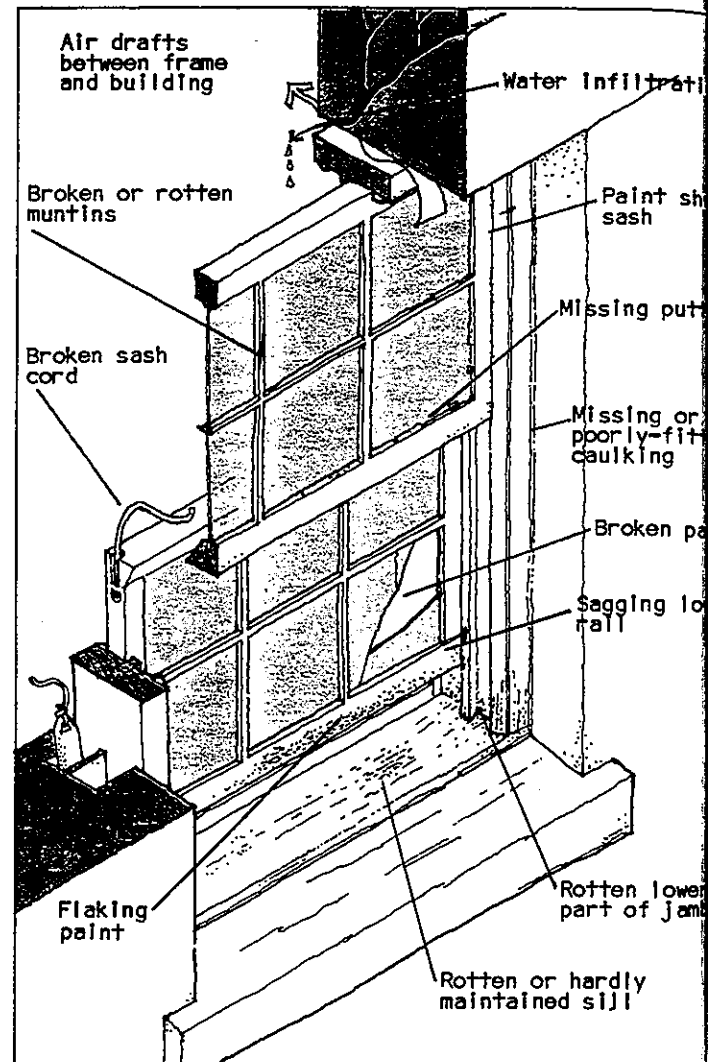

1. Some common problems encountered with windows.

Problems caused by external conditions

Problems with windows are often caused by more general problems with the building.

Poor operation can be caused by deformation of the window opening and frame as a result of structural problems in the walls or foundations, the most common of which is foundation settlement which can be verified by looking for cracks in outside walls, lintels and sills.

In brick and stone cavity wall buildings, check the weepholes (small holes in the pointing designed to ventilate the wall). Look for large cracks on inside walls.

Roofing problems can also affect windows. A poorly constructed parapet or a poorly installed sill can eventually cause damage to a lower window by allowing water to drain onto it.

Inspection table

	Problems	Solutions	Cross-reference
1. Operation			
	Obstructed by excess paint Obstructed by frame or sash deformations Hinges out of kilter Faulty counterweight system	Sanding is usually sufficient Readjust window Wedge hinges Grease pulley-wheels Replace cables or weights	38 41 41
2. Glazing			
	Deterioration of putty Crack in glazing Bulging of leaded-glass	Re-putty Replace glazing Reinforce leaded-glass	40 40 40
3. Paint			
	Peeling, blistering	See chart	31
4. Window sashes			
	Rotting or disassembly of joints Damaged mouldings or profiles Rotting or breaking of muntins	Reinforce joints or inject epoxy-resin Remodel or replace part or all Remodel or replace	36, 39 37, 39 38
5. Frame			
	Insufficient inclination of sill Deterioration of sill Rotting of base of jamb Damaged rabbets Deterioration of parting-bead (double-hung window) Deterioration of woodwork and peripheral framing Wearing or bad installation of weather-stripping	Disassemble and reinstall sill Remodel or replace Remodel (inject consolidating agent) or replace Remodel with plastic wood or profiled wood Install new parting-beads into appropriate grooves. Remodel (use of plastic wood) or replace Replace weather-stripping	35 35, 39 39 37 41 39 42
6. Evaluation of energy efficiency			
	Air infiltration * Inefficient seal * Absence of good weather-stripping Single glazing Absence of accessories such as shutters or blinds	See operation (above) Install or improve weather-stripping Double the glazing, install storm windows Install shutters or thermal shutters or blinds	42 44 54
7. Problems caused by external conditions			
	Structural deformation Poorly constructed openings Water infiltration coming from: * the roof (parapet, ledge) * the upper window * the inside of the wall	Major structure and masonry repair work Repair roof and install flashing above window lintel Repair sill of faulty window and caulking Repair source of infiltration and install flashing above window lintel	

3.2. Evaluation and decision

Adopting a strategy

There is a wide range of possible solutions to problems with windows. Some of these, from the least to the most radical, are:

1. Repair the existing windows;
2. Upgrade the operation and/or energy efficiency of existing windows;
3. Partial replacement: put new sashes into existing frames or replace only one or two badly deteriorated windows in a building;
4. Total replacement: install new windows and frames in the existing openings;
5. Modify the openings: increase or decrease the size of the openings (rarely acceptable on old buildings since it changes the design proportions).

The choice of one of these possibilities depends on:

- * The state of the windows, (how well they operate and how deteriorated they are) as determined by inspection;
- * The role the windows plays in the architectural character of the building;
- * The different kinds of replacement models available;
- * The costs of each option (unfortunately, often only the cost of replacement is analyzed).

Repairing or replacing traditional windows

In general:

1. If the window in place is the original or a replacement window which harmonizes with the facade of the building, it should be repaired;
2. Replacement should only be considered if the existing window is totally beyond repair. In this case, the new window should match the original as closely as possible.



1. Particularly ornamented, old or unusual shaped windows should be conserved.

Where to find help

It happens all too often that the only advice a building owner will obtain before deciding how to deal with older windows is from the salesman of new replacement windows. This is not necessarily an objective source of information.

This technical guide shows that there is more than one way to deal with older windows. Repair is a possibility.

Since this guide may not, in itself, be able to reply to all your questions, it is well worth the effort to do a little more research. The ultimate cost savings in avoiding unnecessary or inappropriate solutions may well be thousands of dollars for a home, and tens or hundreds of thousands of dollars for larger buildings.

The bibliography on page 64 is a good starting point for additional reading. Most of these books should be available in university and public libraries, and in documentation centres of heritage preservation groups such as Heritage Canada in Ottawa and Heritage Montreal in Montreal.

Even if the only modification to the building is the windows, it is generally recommended to engage an architect with experience in renovation and restoration. The cost of professional fees is easily paid back by the fact that costly errors can be avoided.

The tendency to repair instead of replace windows is gaining more and more popularity. But the window repair industry is far from being as well organized as are manufacturers and distributors of new windows. If recent experience in the United States is any example, the repair industry will continue to grow — resulting in reduced renovation costs, and also better preservation of the architectural character of buildings. It might even be worth postponing dealing with problem windows for several years until it becomes easier to get windows repaired and thermally upgraded in your locality.

The advantage of having a large replacement window industry in Canada is that if replacement windows are needed, there is a wide selection of fine quality wood windows available.

In addition to dealing with large companies, it is worth contacting local lumberyards or millyards to find out if they make windows to measure. This is often the most cost-effective method.

You should also consult people in your area who have had windows installed by the various companies, preferably quite a while ago so you can see how durable the windows are. Your municipality or local heritage group might also be able to help you find a good manufacturer.

Costs

The cost of repairing or replacing windows varies enormously depending on the carpenter, manufacturer or installer chosen and local factors such as the distance from a window factory to the site.

Several estimates should be obtained based on a detailed description of the work to be done: the specification. Estimates should indicate the cost of materials and labour (specialized and non-specialized). Performing the simple tasks, such as finishing, can cut costs considerably; consult with the contractor to establish guidelines for the work that you are going to do.

In estimating the costs of replacing the windows, calculate not only the purchase price and insulation cost, consider also the other work which will be involved, removing the old window and frame, changing the opening if necessary, installing new mouldings, and replastering and repainting interior walls.

There is no general rule as to which approach is the most economic. However, if a window is in fairly good condition, it will probably cost less to repair and upgrade its energy efficiency than to replace it with a new one. Even if parts of some windows are completely rotten, it will probably be more economical to replace these parts and even a few complete windows (with exact copies) than to replace all of them.

There is no reason why an older wood window in good condition and properly maintained cannot last just as long (if not longer) than many of the new models of windows available on today's market.

In calculating costs for larger building renovations, it is important to consider the whole project when doing the cost analysis for windows. For example, setting up a small woodworking shop (to repair windows and rout grooves in sashes to allow installation of good weather-stripping) is more economically feasible if it will also be used to repair the interior or exterior wood trim. Similarly, the cost of upgrading the energy efficiency of older windows can be justified not only by the long-term energy savings but also in the short term, since if a new heating system is being installed, one with a smaller capacity can be chosen.

4. Maintenance



Window maintenance has two purposes: to make sure that the window functions properly and to preserve it in good condition.

A few simple **general maintenance** techniques (section 4.1) assure the proper operation of the window. Washing the glass and oiling the moving parts ensures a clear view, good lighting, and easy opening for adequate ventilation.

The purpose of conservation measures (primarily painting), is to slow the process of deterioration which allows longer intervals between repairs and extends the life of the window. Metal elements, putty and especially wood need protection from the elements.

Painting (section 4.2) is the most important maintenance technique. It is essential that wood and other materials be protected from the elements.

The preparatory work depends on the condition of the wood and the condition of the paint or other coatings. The cause of the main problems can often be discerned by analyzing the nature of the surface deterioration (flaking, blistering and peeling) and solutions should be used on these problems before repainting.

Stripping is often unnecessary and can damage both wood and glass. If the old paint is to be removed, certain techniques such as propane torches and sandblasting are to be avoided. The recommended techniques include the use of heat and chemical solvents. If the wood is not going to be stripped, the surface should be sanded (to provide a key for new paint to adhere to) and washed.

In **paint application**, manufacturer's instructions and the correct painting procedure should be followed. For raw wood, one coat of exterior primer and two topcoats are usually used. The muntins are generally painted first, followed by the sash, frame and mouldings. The use of traditional colours should be considered.

4.1. General maintenance

excellent product:

Seiken - stains + paints
- From Holland

Windows should be washed regularly, not only so that they look good but also to prevent accumulation of material which can cause surface damage. A variety of cleaning solutions have long been used, applied with rags or newspapers and then rinsed off. The glass was then polished with chamois, linen or powdered chalk.

Old windows are often covered with a layer of smoke and pollution. To remove this film, use a detergent and a very fine (0000) steel or bronze wool. Rub gently or you will scratch the window.

Leaded windows can be cleaned with a mild ammonia solution (1% to 5%) and then rinsed with water. For the lead comes on leaded windows, use fine emery paper or scrape with a knife. Deteriorated stained glass should be left in the hands of an expert.

Deteriorating putty should be replaced to prevent water penetration which can lead to much more serious problems if not dealt with promptly. (this operation is described on page 40.)

Exterior maintenance should be done carefully (ladders and scaffolding firmly anchored, secured well to window frame when sitting or standing on window sill). When washing the exterior, check the caulking to see if it needs to be replaced (generally every five years).

Hardware should be oiled. It might be necessary to take bolts and hinges off from time to time to completely strip the paint and ensure their correct functioning. Screens and storm windows should also be cleaned and their hardware checked.

4.2 Painting

Paint serves functional as well as aesthetic purposes; besides making surfaces look good, it protects both wood and hardware.

Paint deteriorates over time and loses its protective qualities. The amount of time it takes for paint to deteriorate depends on the quality of the paint, how it was applied and surface preparation. Normally, exterior paint will last from five to eight years.

The most time-consuming part of painting is preparing the surface; this will depend on how badly deteriorated it is.

Painting means working with toxic substances. Most paints contain volatile solvents which are more or less toxic. The majority of paints used before the Second World War were lead based and are extremely dangerous. Some specialty paints and pigments continue to be lead based.

These paints are very toxic to strip, sand, and heat since they release lead fumes or particles.

→ Most paints before
1970 - lead!!

When using strippers, and also when painting, make sure that there is adequate ventilation to avoid fume build-up. Observe the manufacturer's instructions concerning paint storage (avoidance by pregnant women, out of children's reach, away from heat, etc.).

Main problems and solutions

Cracking: Can be caused by aging paint. As paint becomes older it loses its flexibility and can no longer respond to seasonal movements in the wood.

Strip down to the surface of the wood. Apply preservative and then paint.

Flaking: Can occur for several reasons: moisture trapped within the wood because of heavy paint build-up, poor preparation of the surface before the last application of paint, or moisture trapped within the wood or between the layers of paint.

If the cause of flaking is moisture trapped between layers of paint, it should be sufficient to sand down to the sound surface, wash, rinse, and then apply a fresh topcoat.

If water trapped within the wood is causing the paint to flake, remove all the paint. Find the cause of the water infiltration — faulty flashing, caulking or leaks in the roof — and fix it. Then let the wood dry completely (at least 48 hours) and replace any rotten wood using epoxy or a waterproof glue. When the wood is prepared, apply a preservative, wait for it to dry, and then repaint.

Flaking can also be caused by the incompatibility of different kinds of paint — alkyd, acrylic or latex — on the same surface. As different paints age they react in different ways breaking the bond between them and causing the surface to flake and chip. Sand or scrape down to a sound surface and then repaint with a compatible paint. If you cannot find the necessary information about compatibility, phone the manufacturer's chemist.

Chalking: A mild chalking effect is built into some paints so that they will be self cleaning. Chalking can also result from chemicals in the paint no longer bonding to each other, or from too many pigments in the base.

Wash the surface with soap and water and rinse thoroughly. Repaint once the surface has dried.

Alligatoring: Can result from putting a second coat of paint over a first coat that was not thoroughly dry or from decades of paint build-up. It can also result from having painted in the sun or under very high temperatures.

Sand or scrape down to a sound surface, wash, rinse and repaint.

1. Stripping tools:
 1. Scrapers.
 2. Putty knives.;
 3. Cleaning tools, dentist instruments...

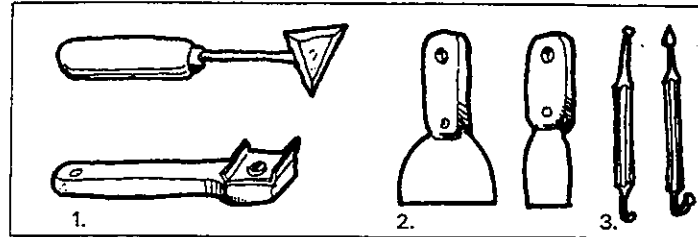

Stripping

Stripping should be limited to cases where the paint surface is deteriorated down to the wood and a simple sanding will not provide new paint with a bondable surface. Stripping is also useful for cleaning the slides and grooves that a window runs or closes on.

Stripping in order to leave wood "natural" for aesthetic reasons is not only historically inaccurate but is technically unsound. Typically, the stripped wood is only waxed or varnished. However clear finishes are ineffective in protecting wood from the ultraviolet rays of the sun. These penetrate the surface of the wood and destroy its binding elements, resulting in greying, warping and, if water is trapped inside, rotting. The result looks like barnboard. Windows which could last for a century are doomed to deteriorate in a few years if they are not adequately protected.

The choice of stripping technique depends on the amount of work and the variety of grooves, moulding and ornamentation.

Techniques to be avoided: Certain stripping techniques should be avoided. Propane torches can burn the wood and present a real fire hazard, for example, by igniting dust within walls.

Abrasive techniques like sandblasting and orbital sanders can ruin fine details. Sandblasting destroys the soft summer growth grain in wood, leaving the hard grain to stand out and producing a rough, ridged surface. On flat surfaces (sills, jambs ...) orbital sanders and sanding blocks with fine sandpaper can be used with little risk.

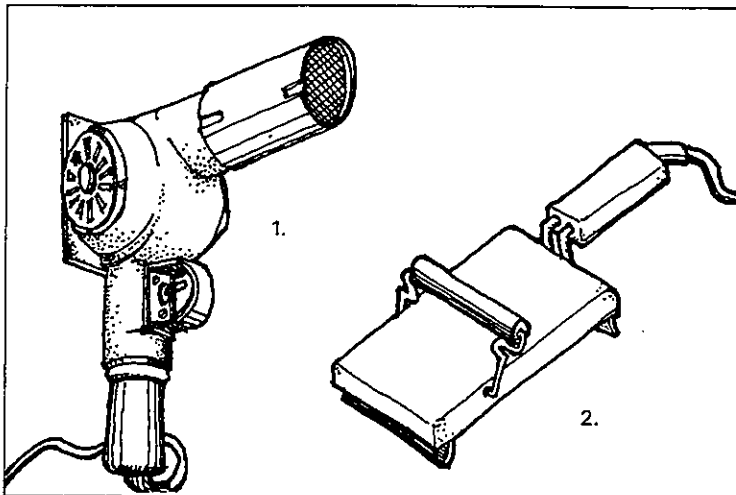

Heat: A heat gun is similar to a high powered hair dryer with a heating element and a fan which blows the heat onto the surface. It is especially useful for complex forms. The heat plate contains an electrical coil in a plate which is raised off the surface of the wood. It is used on flat surfaces.

These tools lift the paint without scorching the wood although if left in one place for too long, they can damage the wood. High temperatures can cause the different coats of paint to fuse together and they may ignite easily. If the heat is too high, it will release the toxic lead fumes in the paint.

Sudden application of heat to glass can cause the glass to crack; the older the glass, the more fragile it is. Protect the glass by taping it with a heavy duct tape or by using a thin asbestos sheet.

Chemical solvents: Chemical stripping is carried out in two steps: applying the stripper and then removing the paint. Strippers vary in their composition and manufacturer's instructions should be carefully followed. There are water-based strippers and chemical-based strippers.

After applying the stripper, it should sit on the surface until the paint starts to bubble. A piece of waxed paper can be applied on top to keep in the fumes and maximize effectiveness of expensive chemicals. Too much stripper can damage the wood by drying it out and destroying the bond between wood fibers.

Do not use heat together with strippers. Solvents are highly volatile and the combination of heat and solvent could result in fire.

After the paint has been removed, neutralize the chemicals and wash the surface well because trace elements can deteriorate the new finish.

Removing paint: Removal of softened (heat) or dissolved (chemical) paint proceeds in several steps, from the coarsest to the finest details. Start with broad bladed scrapers and putty knives to remove the bulk of the paint. Use screwdrivers, nails, or dentist tools when working on fine details. Finally, go over the entire surface with steel wool. After the stripping is completed, wash the surface with water or solvent to remove any remaining chemicals.

2. Stripping tools using heat:

1. Heat gun.
2. Electric heat plate with scraper.

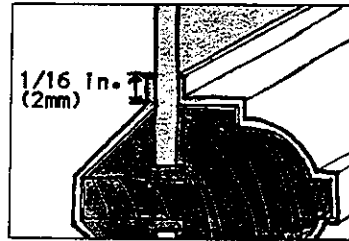
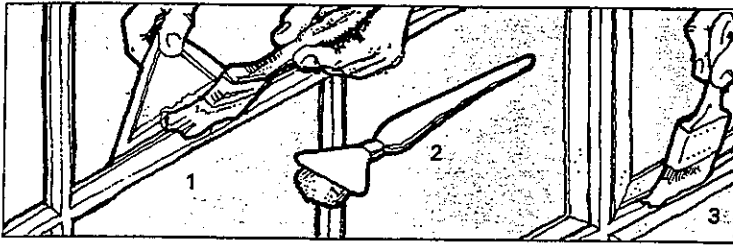

1. **Painting the muntins:** as shown on the immediate left, the paint should seal the pane. Use a shield (1), a shielded paint-brush (2) or masking tape (3) to protect the glass from paint.

Painting

Manufacturer's instructions contain guidelines as to the best conditions in which to paint. Painting in weather that is too hot, too cold, or too humid should be avoided since it will soon result in peeling or flaking paint. Painting in direct sunlight can cause the paint to dry too rapidly, before it bonds properly with the wood.

Stripped or new wood should be treated with preservatives before being painted. They generally contain a waterproofing substance (often a liquid synthetic wax) and a fungicide (such as the highly toxic creosote and pentachlorophenol or the preferred CCA). They should be allowed to dry thoroughly before painting (at least 2 to 3 days). Knots should then be shellacked.

If the old paint is in reasonably good condition and is not being stripped, it should be sanded, washed with a mild solution of trisodium phosphate and rinsed thoroughly. Before applying one kind of paint on top of another, check with the dealer or manufacturer to ensure compatibility.

Primer-sealers provide a tooth over glossy surfaces for subsequent coats of paint to adhere to. They also partially mask previous paint colours and dry quickly to allow a second coat of paint to be put on in the same day. Primer should also be applied on new or stripped wood.

A light sanding between coats will give the paint a firmer adhesion. The paint on mouldings or putty should overlap 1/32 inch (2mm), onto the glass to keep out moisture. Windows should be opened and shut several times in the hours and days after painting so that they are not painted shut.

Double-hung windows: The upper and lower sashes should be reversed to allow painting the upper rail of the lower sash and the lower rail of the upper sash. When two pieces of wood meet, paint only one at a time.

Start with muntin bars (if any). Painting guides or tape can help keep paint off the glass (although paint inevitably gets underneath and guides are no substitute for a sure hand).

If possible, the interior sash runs should never be painted. If stripped, the wood should be sealed with a stain or varnish and then waxed with a hard wax.

Casement Windows: Start with the muntins. After all the squares are done, open the windows so that you can cover the entire surface of the stiles, the vertical members of the frame and the rails, the top and bottom pieces. Finish by doing the frame and then the exterior mouldings. If you are painting the frame from the inside, reverse the procedure, and start the frame with the exterior mouldings.

Colours: The choice of colour should depend not only on personal taste but also on the traditional colours used on the building, especially on buildings of particular historical

value. Even if historic colours are not to be used, it is interesting to find out what the original colours were by scraping and sanding down to the first coat of paint. (See page 15.)

Colours went in and out of fashion very quickly: first white, then pale earth colours, then dark tones of the mid-Victorian era, then pastel shades. Each new fashion rejected the preceding one and many older buildings displayed each colour during its life. Thus the present colours or even those remembered by elderly people are not necessarily the original ones.

In the 17th and 18th century, windows were painted white. Later, the frames were painted lively colours. Towards the end of the 19th century, windows were painted in darker shades than the rest of the facade to create an impression of depth. The sashes were often painted in a different colour from the frame which required particular care but prevented the sash from being painted shut.

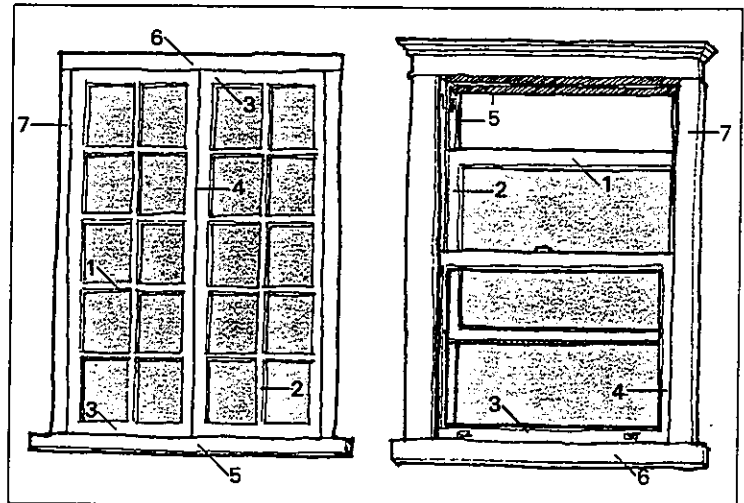

2. Sequence to be followed when painting casement or double-hung windows.

Painting the window will be easier if one can manipulate the sashes: use a handle or a nail inserted into a part where the mark will not be visible (for example, under the lower cross-bars). The holes left by the nails or hooks must be sealed so that water does not get in.

The sash-runs of double hung windows should not be painted but varnished and waxed in order to help the sashes slide properly.

5. Repairs

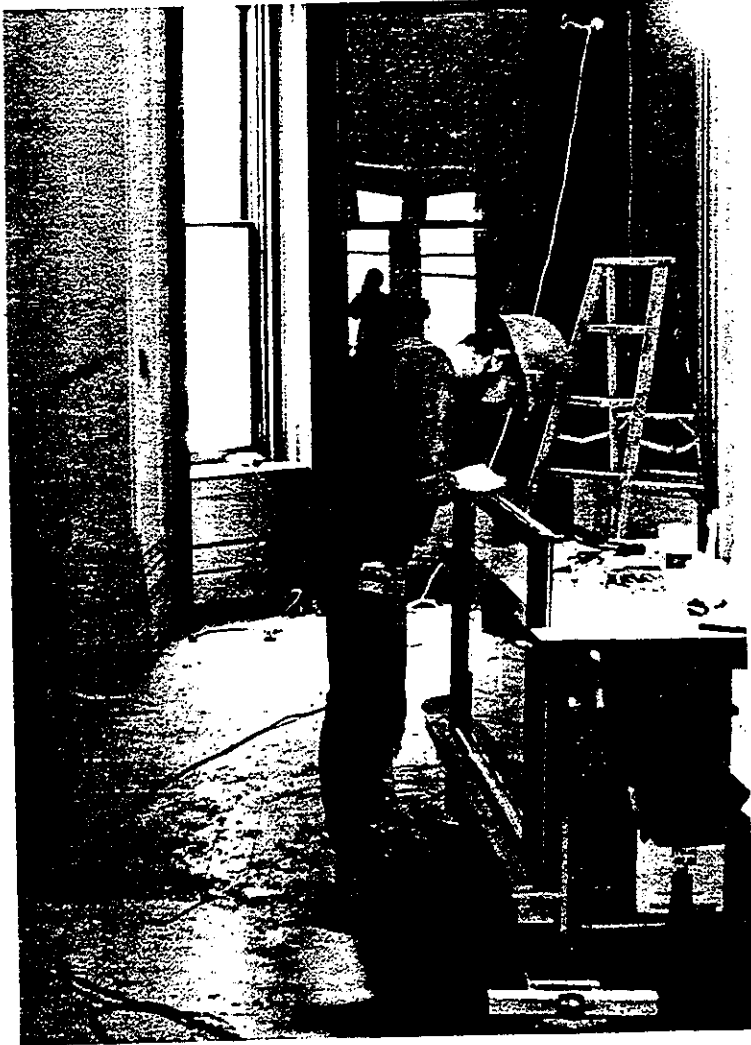

This chapter deals with two principle types of major intervention on existing windows: repairs to remedy defects in the form and operation of the window, and improvements to energy efficiency.

There are a number of relatively simple repair techniques which are valid alternatives to the replacement of windows: the various wood elements can be rebuilt with the help of plastic wood or semi-rigid epoxy resins, new pieces of wood can be glued in place and then shaped to the exact form of the original.

This chapter sums up the principal repair techniques of sills (section 5.1), sashes (section 5.2), mouldings and profiles (section 5.3) and muntins (section 5.4). It will also show how to straighten the sash (section 5.5) and do surface repair (section 5.6), using epoxy and other techniques. The chapter also deals with glazing (section 5.7), including leaded glass, and hardware (section 5.8), namely hinges and counterweights.

A number of techniques exist to substantially improve thermal efficiency of older windows to the point where they can be the equivalent to new windows. They include proper caulking, installing weather-stripping and improving the glazing by using thermally sealed double glass or adding storm windows.

5.1 Sills

Repair

The window sill is the part of a window which most often requires repair. As it is located at the bottom of the window opening, it is here that moisture will accumulate and cause rot.

Moisture can come from an improper slope on the sill (i.e. sloping towards the building, causing water to enter) or other defects in the window or surroundings.

A temporary solution is to cover the sill with sheet metal. This might in fact hasten rot and should only be used as a short term measure when eventual sill replacement is considered inevitable anyway.

The proper solution is to repair deteriorated wood, replacing badly deteriorated portions.

If there is simply superficial damage, holes and cracks can be filled with plastic wood, semi-rigid epoxies or putty. When using a paste type filler, overfill and when dry, sand until level. This prevents hollowing caused by contraction during drying or curing.

Dowels and wedges can be used to fill cracks and larger holes from which all rot has been removed. Waterproof glues should be used to secure them.

If rot has deeply penetrated the sill, chisel the rotted wood out down to sound wood and square off the cut. Cut out a new matching piece. Use pressure-treated wood. Alternatively, regular wood soaked in preservative (5 minutes per inch of thickness and 24 hours of drying time) can be used. When dry, glue it with waterproof marine glue and screw it into place burying the screw head. Make sure that the grain of the replacement wood runs in the same direction as the old. This will allow the new wood to work under seasonal pressures in the same way as the old.

Alternatively, new techniques of epoxy repair can be used to repair even badly rotted sills without removal or, in fact, any woodworking at all (see page 39).

Replacement

If most of the sill is rotten, or if water infiltration has attacked the underside of the sill or other parts of the wooden structure, the sill should be replaced.

Start by removing mouldings and other woodwork enclosing the sill. In older windows the sills are generally joined to the frames with a half mortise and tenon joint. The sill fits into a groove in the jamb of the frame. Prior to removing the sill, remove the apron and the moulding; in the case of mortise joints, counter-sink the pegs with a nail-punch.

To remove the sill, saw it into three parts, remove the middle piece, and then pry out the two end sections. Before replacing the sill, place building paper on the opening to avoid contact between the wall and the sill. The new sill should slope away from the wall by at least 10° to efficiently drain water.

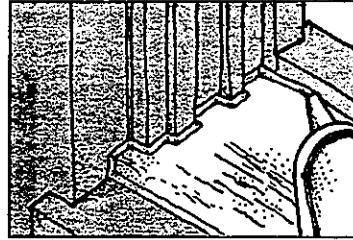

1. **Temporary sheet metal covering:** This solution should only be used to postpone inevitable replacement (see text). A sealing product is applied to the edge of the window sill and on the joint with the jamb. Sheet metal is cut to fit between the jamb and then nailed down. (Make sure the wood is completely dry.)

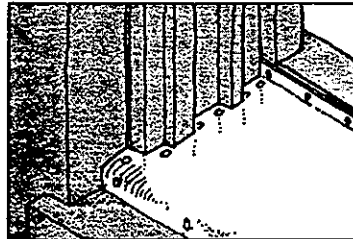

A ventilation space must be left between the sheet metal and the wood by leaving occasional gaps in the sealant where there is no risk of water penetrating.

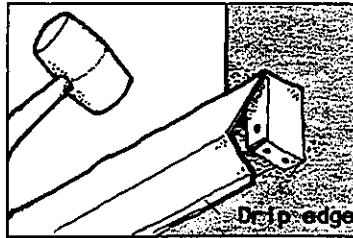

2. This type of covering offers only limited protection against the elements and requires careful cutting and caulking. If the sheet metal also covers the edge of the window-sill, it must be folded so as to form a drip edge.

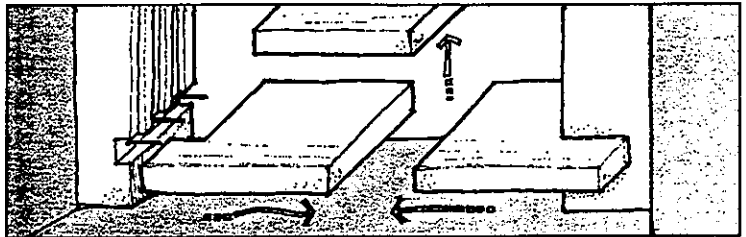

3. **Removal of window-sill**

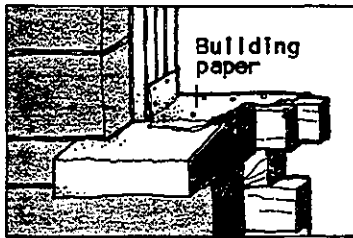

4. **Preparation of opening:** placing building paper.

There are two basic problems with sashes: rot and deformation due usually to problems with the joint.

Since the end grain of wood sucks moisture into the wood, joints are the highly susceptible to rot. The lower members are other weak points since they come in contact with the sill where moisture accumulates.

Semi-rigid epoxies can strengthen and protect wood and also reinforce deteriorated joints. Although this method can be more expensive than other techniques mentioned below, it permits the rebuilding and waterproofing of mouldings and grooves (see page 39).

There are two ways of replacing drip mouldings of casement windows. If the whole bottom rail is rotten, have a cabinet-maker make a similar piece of wood and install it in a traditional manner using grooved joints. If only the moulding is being replaced, it can be applied on the surface or in a groove using waterproof glue and screws. Seal joints with caulking, not just paint (see page 37, fig.4).

Before reinforcing joints, square up the window with diagonal wires. Joints can be firmed up with angle irons and braces. These can offer good short-term solutions but it should be remembered that the metal can rust and the screws create a path for moisture (and, therefore, rot) to enter the wood.

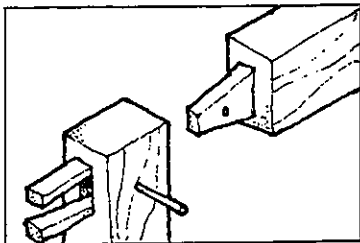

1. Jointing of old sashes: Mortise and tenon assembly held by a dowel and wedge (which tend to come out of the mortise).

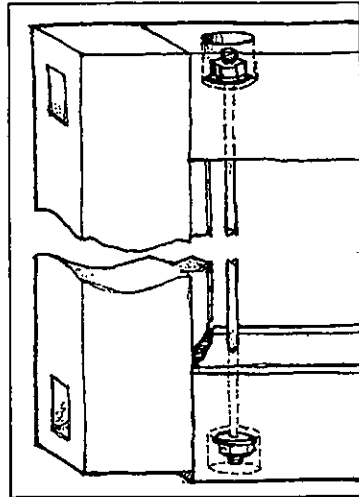

2. Raising a sagging lower rail: Near each stile, a metal rod which is threaded at each end is bolted to the lower and upper rails. It is then possible to raise the lower rail by tightening the bolts.

Permanent solutions take a little longer. They involve rebuilding or replacing the original fastenings. Take the window out of the frame and use a square jig to make sure the window is square. Then drill through the members where the mortise and tenon join, and insert dowels. The wedges on the side of the stile should also be reglued and set.

If the sash is warped, the wood might have to be moistened and then redried while held in a square position. (Leaving them on a wet lawn for a day will sometimes restore them to a square state unless the wood originally was set in a warped pattern.)

On large double-hung windows, a metal rod can be used to reinforce a lower cross-bar that has sunk under the weight of the glass pane (see fig.2).

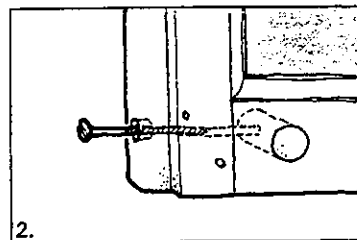
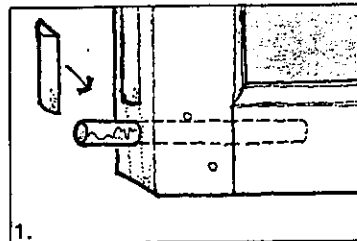

3. Reinforcing the corners of the sash:

1. Hardwood dowel glued and inserted into a hole which goes through the tenon to the rail.
2. Long screw inserted through the tenon. A hardwood dowel in the rail can be used for reinforcement. The head is hidden with a piece of dowel or wood filler.

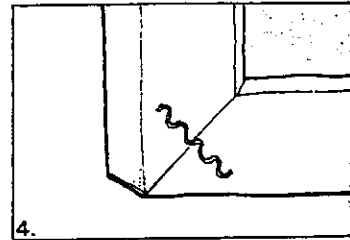
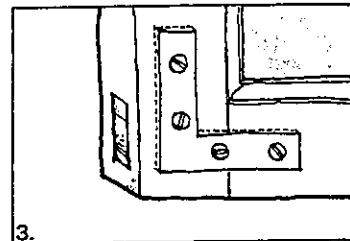

3. Metal angles are not generally acceptable unless they can be installed unobtrusively such as by being sunk in.
4. There are fasteners made out of metal specifically made for reinforcing corners of frames. Their use should be limited to the frames of screens or light accessories which are not subjected to the stresses imposed on sashes.

5.3 Mouldings and profiles

The basic repair steps are similar to the other wood elements described above: remove rotted wood and replace with new wood or consolidate and fill with epoxy.

Interlocking joints and grooves in casement windows are particularly exposed to moisture and, therefore, especially susceptible to rot. If there is no drainage channel in the groove, make a 1/8 inch (3mm) saw cut in each joining member with a combination saw.

Pieces which have to be replaced should be cut out, new wood glued in place and then shaped with a bullnose plane or sanding block to match the original profile (see fig.1-5).

The basic principle is to attach the new piece in such a way that the original strength of the member is not lost. It is best to use a glued half lap joint, with the grain of the wood running in the same direction (to allow new and old wood to work as a whole under the pressures of seasonal expansion and contraction) and reinforce with glued dowels.

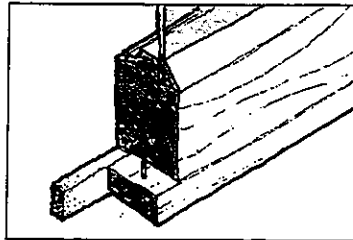

3. Replacing the bottom of the rail of a double-hung window: After planing the length of the rail, one either nails or screws on the new wood. One can take advantage of this operation to install weather-stripping (see p.43).

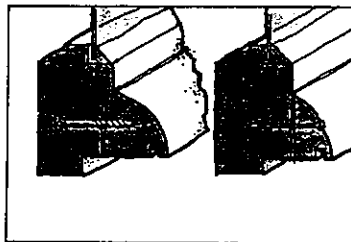

4. Replacement of the drip moulding: The joint between the moulding and the lower rail is sealed by a coat of paint and requires regular maintenance. Caulking should also be used before painting (see p.42).

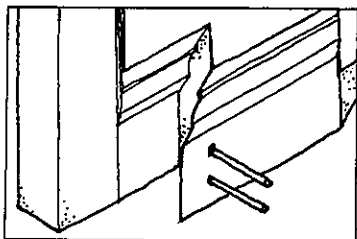

1. Simple mitered joint: the joint is simply glued and dowels are inserted in pre-drilled holes.

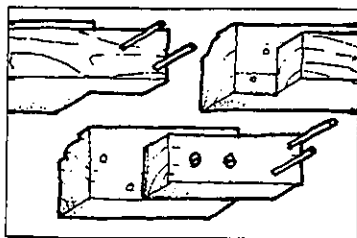
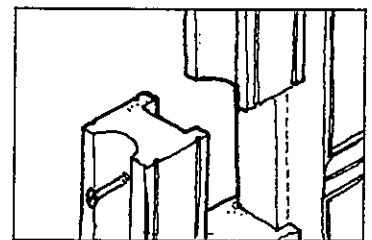
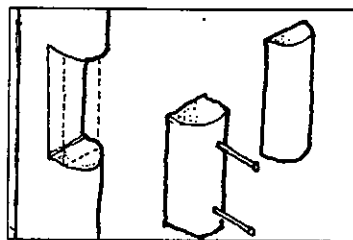

2. Lap joints: the replacement part (called a dutchman) can be made from one piece or in two parts that are glued and screwed together. The latter method can be used on complex joints (see diagram to the right) which otherwise could only be replaced if the sash were removed.

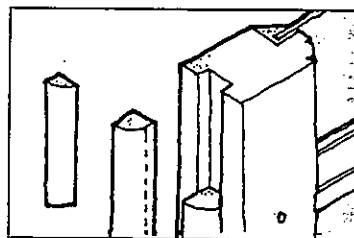
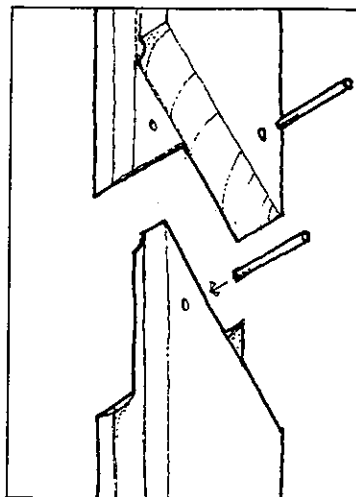

5. Repair of stile mouldings: The damaged parts are removed with a saw or chisel. Finer mouldings are inserted into grooves to limit deformations.

5.4 Muntins

Muntins are the most fragile members of a window: inside, they are exposed to moisture caused by condensation, outside, they are exposed to moisture wherever the putty is deteriorated. Muntins can be repaired with epoxies or wood fillers, or new pieces of wood can be glued into the existing muntin and then shaped. Seriously rotted muntins should be replaced.

The principle muntins are continuous from one side of the sash to the other; to replace them, the entire sash has to be taken apart because they are joined to the sash at both ends.

Secondary muntins are joined either to a stile and principle muntin or to two principle muntins. To repair secondary muntins, remove glass on both sides of the muntin to be repaired. Saw the muntin in half and remove it. Saw the new muntin in half along a diagonal, replace each half and then glue, screw and clamp the muntin. It should be clamped for 12 hours.

If you cannot find an exact reproduction of the muntin you need, a closely matching piece of bevelled moulding might be acceptable.

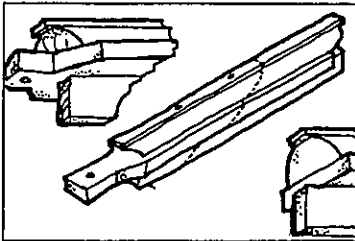

1. Replacing muntins: The joints (which are generally tenon and mortise) are reproduced. Pegs should be inserted in pre-drilled holes. Insertion of the muntin is facilitated by sawing the part into two pieces (on a slant).

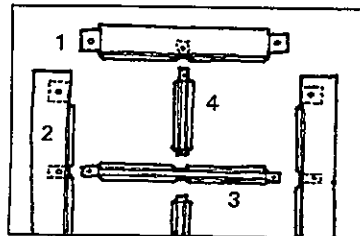
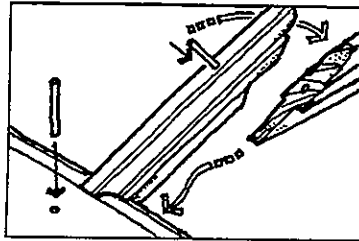

5.5 Straightening the sash

Out-of-plumb window frames are often caused by structural shifting of the building. Sinking foundations, sagging or cracked lintels, bulging brick walls and other structural problems must be fixed or at least stabilized before attempting to level or square the window.

The degree of frame straightening required depends on how badly the window has shifted, whether it still works properly, how the window was anchored to the wall and the complexity of the window trim.

After removing the sash (which should also be re-squared), remove all mouldings to expose the frame casing. The window opening should be checked for obstructions. The frame should be shimmed until plumb and level, and then reattached.

In some cases it will be impossible to straighten the frame. In this case, the sash can be either planed until it fits the frame or wedges can be attached to correct the inclination of the frame. These strips should be treated with wood preservative before gluing and screwing them to the frame. Make sure that all joints and screws are covered with plastic wood before painting. It might be necessary to add mouldings to correct the visual appearance of the frame.

2. Replacement of a muntin: Each piece is installed into the mortise of the frame or onto a muntin, then the angled cut is glued and reinforced with pegs.

3. Sash assembly:
1. rail
2. stile
3. principle muntin
4. secondary muntin

5.6 Surface repair

Rebuilding

Although replacement of deteriorated wood members is sometimes the only solution considered, good results can often be obtained at a lesser cost by rebuilding the deteriorated members.

Although the cost of materials is sometimes higher, there is less work and it can often be carried out by relatively unskilled labour. Homeowners with some rotted windows and limited woodworking skills can probably carry out the necessary repairs without even having to bring in a carpenter.

If the damage is minor, plastic wood will generally do the job. Putty, caulking products with a latex base, plaster or glue mixed with sawdust, can all be used to fill in visible surface damage.

In the past few years, wood repair has been revolutionized by the introduction of epoxy resins. Although too expensive to be used for most large scale wood repairs, they are ideally suited to window repair. Their advantage is that they can follow the movement of the wood while other wood filler (with the exception of latex caulk) dry out, remain rigid, and come away from the wood. Epoxy resins are waterproof and thus better for exterior repairs. Their drawback is that they restrict the wood's ability to breathe.

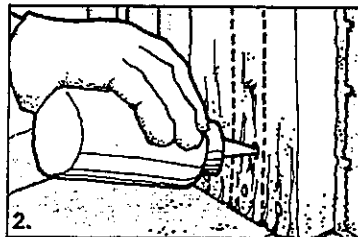
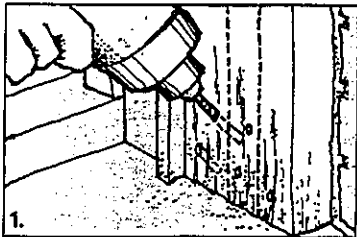

1. Use of epoxy resin to consolidate the base of a rotted jamb.

1. After having scraped the wood and removed the debris, angled holes are drilled without totally piercing through the piece of wood.
2. When the wood is dry, the liquid resin consolidant is injected into the holes and applied with a brush over the jamb. Finally, the surface is reconstituted with a resin that is more pasty.

Epoxy repairs

Epoxy can also be used for major repairs. This work is done in two stages: consolidation and filling.

Consolidation is done by applying a penetrating epoxy resin with a brush. When the wood is thicker or inaccessible, drill 1/4-inch (6mm) slanted holes into the wood and inject the resin (using an old plastic squeeze bottle).

Bonding agents should be added to resins used for consolidation. Sometimes sawdust or powdered glass is used in the mixture. When mixed, the epoxy resins set up very quickly and should be used without delay (1/2 hour to 3 hours).

The epoxy used for filling and shaping is applied in the same way as wood filler or putty. It normally does not shrink when curing. Once hardened the resin can be worked like wood. Since heat caused by the curing of the resins may damage the wood, it is preferable to fill large gaps in stages.

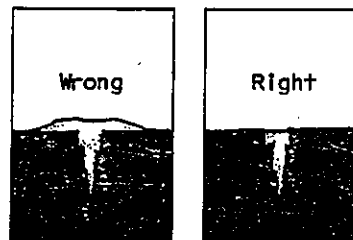

2. As little resin as possible should be left on the surface, to avoid trapping water.

5.7 Glazing

Repairing glazing

The water-tightness of a window pane depends on the condition of the pane and the putty that seals it.

Broken glass should normally be replaced. However, cracked decorative or historically important glass can be reglued. Clean the edges with acetone and then apply a clear, fluid glue. Certain kinds of epoxy can be used for this but some have a tendency to yellow with age.

Even if the putty is only partially deteriorated, it is better to remove all of it from a window. Heat the putty lightly while protecting the glass with a thin sheet of asbestos (or with gypsum board covered with aluminum foil). Chemical solutions such as muriatic acid, paint stripper or caustic soda can be used to break up the putty. If you use solvents, neutralize the chemicals by rinsing the muntins and glass afterwards so that trace elements do not erode the new putty. Wear safety goggles and gloves and provide adequate ventilation when using solvents.

If the glass has shattered, remove it before removing the putty (wear gloves and safety goggles). Heat the putty and then remove it with a scraper. Be gentle to avoid gouging the wood.

Sand the groove and apply a coat of primer or a half-and-half mixture of linseed oil and turpentine. If the wood is not sealed it will draw in the oils from the putty. This will cause the putty to crumble very rapidly.

Before using the putty, knead it to make it softer. Lay a thin bed of putty, 1/8 inch (3mm) thick, on the muntin. The window pane should be 1/8 inch smaller than the actual dimensions of the opening. Press the glass against the putty and install glazier's points every 8 inches (200mm). Use a screwdriver or the flat part of a scraper to drive in the points.

Apply the putty in a loose roll. Then pack it into place with the flat side of an old chisel. Finally, run the chisel along the putty in a

continuous motion at 45°. If there are any bumps or ridges, use a wet finger to smooth them out. Wait a few days until the putty hardens a little before painting. If possible, lay the window flat while the putty hardens.

Repairing leaded (stained) glass

In addition to the deterioration of putty or lead cames, the principle problems of leaded glass are bulging, and broken or missing glass. It might be wise to seek the help of a stained glass specialist, especially if the swelling exceeds an inch or the pattern is complicated.

The first step in repairing a bulge is to remove the damaged panel from the frame. A slight bulge can be repaired by supporting the glass on one side and gradually weighing it down with light objects such as books. Once the panel is flat it can be reinforced with steel rods that are inserted or screwed into the frame. The rods are then soldered to the cames or tied to them with copper wire.

To remove broken glass, the cames can either be unsoldered or cut. If the cames are unsoldered their pattern should be recorded beforehand by rubbing a piece of charcoal on a sheet of paper covering the window. The entire dismantled section will have to be re-puttied.

If the cames are cut, use a knife to open the grooves surrounding the broken glass. After the new glass is installed a strip of lead is soldered back onto the came and puttied. Before soldering the lead must be cleaned and the soldering itself must be executed rapidly so as not to damage the glass.

When the panels have been removed from their frames they should either be kept between two stable surfaces (plywood) or reinforced with tape (on unpainted surfaces) to prevent damage caused by movement.

1. Putty joint:
 1. putty bed (1/8 inch [3mm])
 2. glass (1/8 inch to 1/4 inch [3 to 6mm] thick and smaller than the size of the frame)
 3. putty covering the groove
 4. paint covering the glass in order to seal it (1/16 inch [2mm] overlap)

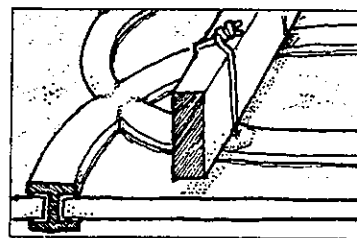
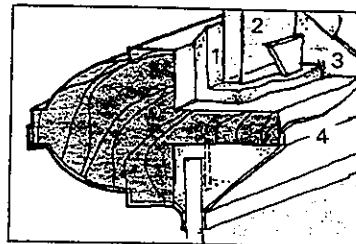

2. Reinforcement of leaded windows: Iron rod fixed to the glass panel with copper wire soldered to the lead cames.

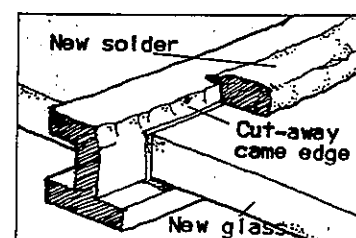

3. Replacement of a broken piece of glass: The came is cut with a knife, the new piece is placed on a bed of putty and sealed by soldering.

Hinges

With time, hinges become loose either because of the wear on the wood screw-holes or on the metal itself. Hinges must be removed, either to replace them or reinforce the wood that holds the screws.

When repairing the wood, first clean out the old screw holes using a drill bit larger than the old hole. Then glue a dowel into the hole. Let the glue set for at least one hour and then redrill (in a diameter slightly smaller than the threads on the screw) and reattach the hinges.

The various closing mechanisms for casement windows, (flat bolts, casement bolts) generally require only regular maintenance, such as oiling and occasional stripping when too much paint builds up. Repairing broken hinges will require welding or forging. If you are having replacement parts forged or made by a metal-worker, get some extra ones made at the same time. Some closing mechanisms of the 19th and 20th centuries are easily dismantled for maintenance and repair.

Repairing counterweights

The usual reason double-hung windows do not operate freely or get stuck is because the sash runs are blocked with paint. First try lubricating them with wax or soap. If this does not adequately improve their functioning, the sash runs will have to be scraped. Slides were never meant to be painted. Originally they were stained and waxed or varnished and waxed.

A somewhat more serious problem is a broken sash cord, but this too is very easily remedied.

Counterweights are inside pockets on the inner side of the window frame. These are accessible through traps at the bottom of each sash run. Usually the traps are held in place by a screw (fig.3). Sometimes it is hard to make out the outline of the trap because of excessive paint build up.

To change sash cords follow this procedure. Take a sharp utility knife and cut the paint bond on the interior window-stop moulding (the decorative moulding on the inside of the window). If the moulding is attached with screws or nails, remove them. Pry the moulding off with a putty knife.

When the moulding is removed, slice the paint bond that outlines the trap, remove the screw, and gently pry out the trap. The weight should then be visible.

Take a length of sash cord or sash chain and tie a long thread or string to one end. At the other end attach a weight, such as a nail, screw or bolt. Lower the thread over the pulley until you can reach it through the trap. Use the string to pull the sash cord down. Tie it to the weight.

The side of the sash has a groove which runs down to a larger opening. The cord is run down the groove and knotted in place in the opening. To establish the length of the sash cord first pull the weight up to the top of the pulley. Resting the window on the sill, run the cord through the channel. Then leave one or two inches of play on the cord and nail or screw it into the side of the sash.

If it is the upper exterior sash cord which needs replacing, first remove the lower window and then the parting bead (the moulding that separates the two sashes). Cut the paint bond with a sharp knife. Screw a cup hook into the bead for leverage and then gently pull it out. Follow the above procedure for replacing the cord.

The pulley and weight system can also be replaced by a self-contained spring loaded unit. The unit fits into place where the pulley originally rested and a spring-loaded band is fitted to the sash.

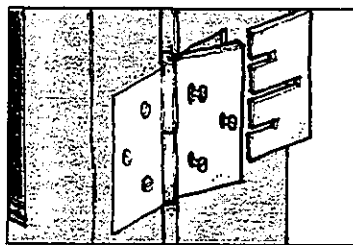

1. **Wedging hinges:** The swing can be adjusted by inserting a shim or a wedge made from thick cardboard.

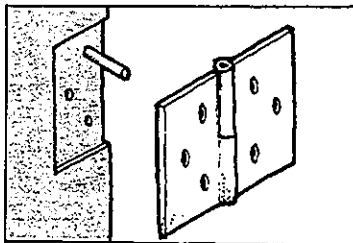

2. **Reinforcing hinges:** Wooden pegs are glued and inserted into the screw-holes before re-installing the hinges to the sashes or stiles.

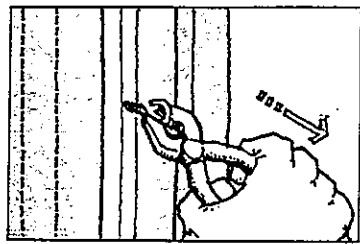
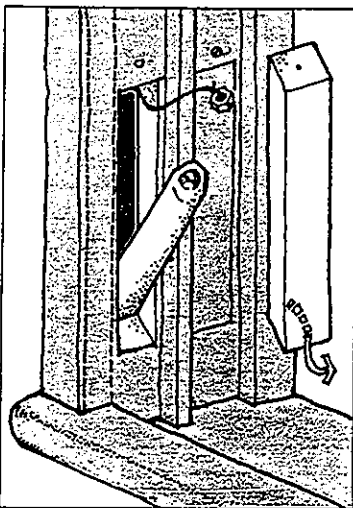

3. **Replacement of the sash cord:** In order to get to the counterweights, the trap must first be removed. To reach the exterior sash, the parting bead is pulled out by screwing a cuphook to it (diagram above); make sure that the parting bead is not screwed on to the frame before pulling it.

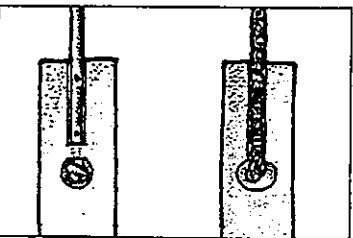

4. **Fixing sash cords and chains to the sash:** For the cords, a simple knot can be enough; in large sashes, it is advisable to nail them.

5.9 Improving thermal efficiency

Caulking

The gaps between wall and frame, as well as the joints between fixed elements of the sash, should be adequately filled and caulked to make them water and air tight (see page 14).

Large gaps such as the one between the window box and masonry wall or exterior siding should first be filled with mineral wool or fibre glass. Smaller joints should be sealed with an exterior semi-rigid filler (such as epoxy or latex-based caulk).

To install, clean out any loose or flaking material between the window frame and the wall. Make sure that all surfaces being worked on are dry and clean. Fill the gap with mineral wool or fibre glass. To be efficient, fibre glass depends on air pockets within the material; therefore, it should not be compacted. Use a screwdriver or putty knife to stuff the cracks.

Then cover the window with a caulk compatible to both the window frame and the wall materials. If the gap is larger than a 1/4 inch (6mm) you should put some backing, such as polystyrene foam, into the gap before caulking.

On the inside, some of the window moulding might have to be taken apart to find and seal points of air infiltration.

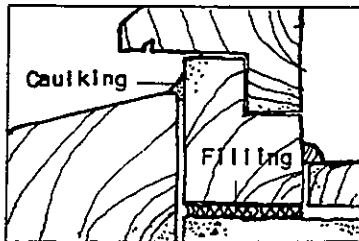

1. Filling and caulking a sill

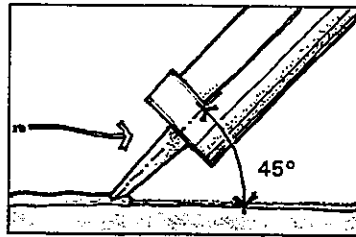

2. Caulking with a gun: Push the compound into the joint while moving the gun towards you with a 45° angle. This should be done slowly in order to prevent stretching the bead.

Installing weather-stripping

The purpose of weather-stripping is to make watertight joints between moving and fixed elements, such as the frame and the sashes.

Traditionally, detailed carpentry such as interlocking joints and moulding served as a crude form of weather-stripping. This system was efficient at first but eventually the joints would open because of wood decay, shrinkage and warping.

During the 19th century, copper and bronze sprung-steel weather-stripping came into use. In double-hung windows, the upper and lower frame, the interlocking joint between the two sashes and the slides were covered. In casement windows, the stripping went all around the frame and the sash closed on it.

Today, many types of weather-stripping are available offering a wide range of price and quality. Starting with the easiest to install and least expensive — which are also the least effective and durable — they are: foam, wood-backed strips, vinyl and metal.

1. Foam: One of the simplest ways to increase the thermal efficiency of old windows is to place strips of foam or felt in or next to the sash run. This type of weather-stripping is good for irregular joints or when the wood is warped. It follows the form of the joint when the window is closed. Foam and felt weather-stripping generally come with a self-adhesive backing and can be directly applied to interlocking and moving parts. They are only effective under compression (horizontal rails of a double-hung window and all sides of a casement window). They normally last for a couple of winters.

2. Wood-backed strips: Foam and felt are more durable when they are glued to a wood moulding. The strip is nailed to the frame or the sash and can be removed in the spring. The wooden strip will deteriorate with time. If the insulation is painted it will lose its elasticity. Again, these types of insulation are not very effective on the moving parts of double-hung windows.

3. Vinyl: Windows can be surrounded by permanent weather-stripping made of either vinyl or metal (aluminum, copper or bronze). The most widely used vinyl weather-stripping is a tube nailed to the sash next to the sash run. This type of weather-stripping is quite durable but it is not discreet and it is incompatible with certain paints.

4. Metal: There are two kinds of metal weather-stripping: the spring-loaded kind which has already been described, and the interlocking kind which consists of a tongue that fits into a channel. These are usually made of zinc or aluminum; in some models, felt or foam is used in the cavity to increase the insulation or decrease friction.

Metal weather-stripping is the most aesthetically pleasing and durable solution to the problem of air infiltration. It can make a substantial improvement in the energy efficiency of older windows.

Finally, it should be noted that, in winter, it is possible to totally seal the window with a strip of putty which is removed in the spring.

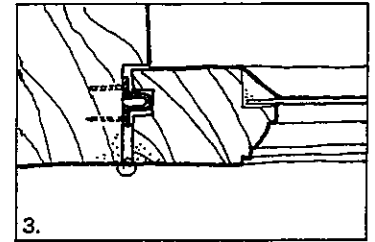
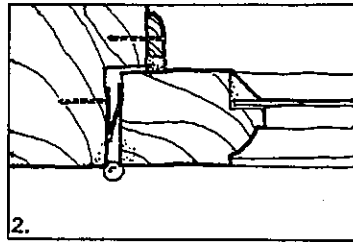
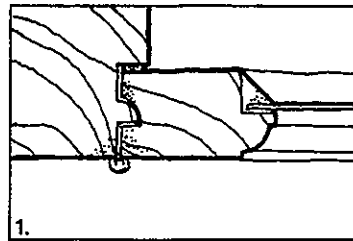

2. Casement windows:
placement of weather-stripping on the hinged stile.

1. Traditional method.
2. Metal spring-loaded stripping and foam-backed moulding.
3. Folded metal channel.

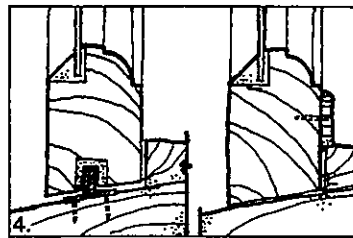
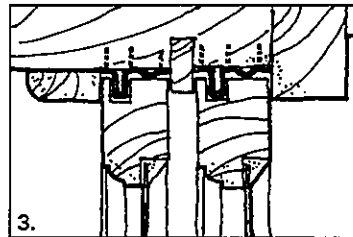
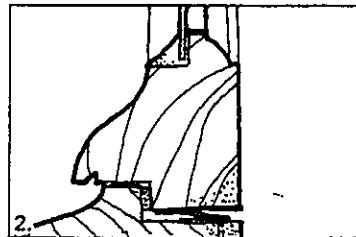
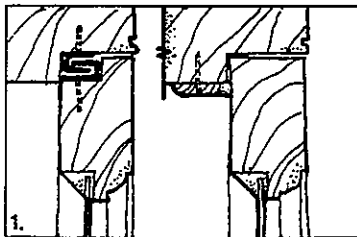
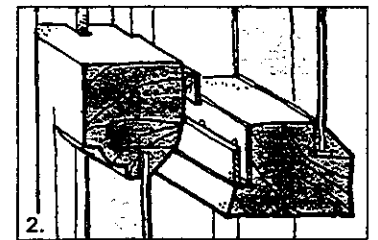
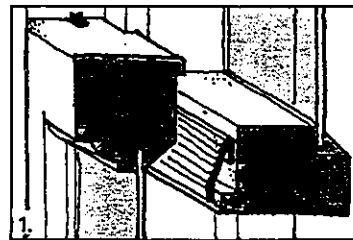

1. Weather-stripping on casement windows:
1. metal channel (left) and foam glued to a strip of wood (right) on the top of the frame.

2. metal spring-loaded stripping and felt, installed the length of the window-sill.

3. Double-hung windows:
Typical details for the meeting rails (1 and 2), sides (3) and bottom (4) of the sash.

1. Metal spring-loaded stripping at the meeting rails.
2. Interlocking metal channels for meeting rails.
3. Folded sheet metal attached to the sash runs running in grooves routed in the sides of the stiles.
4. Folded sheet metal installed on the window-sill containing weepholes for rain or condensation (left), foam-backed moulding mounted on the bottom rail (right).

Improving the glazing

Caulking and weather-stripping eliminate air infiltration, usually the principle cause of heat loss associated with windows. The next most important cause is radiation and conduction which depends mainly on the glass.

Direct radiation loss is almost totally eliminated by using a window pane 1/16 inch thick (1.5mm).

However heat loss by conduction occurs when the glass heats up and convection currents transmit this heat to the exterior. Also, the resulting condensation can cause rot and accelerate wood deterioration. Heat loss by conduction can be reduced by more than half by installing double glazing or adding a storm window (see fig.1).

Double-glazing on an existing sash: There are several ways of doubling the glazing on an existing window, some of which require little modification to the window itself. The structure of the window must first be analyzed in terms of whether it is strong enough to support the extra weight. In any event, extra weight must be added to the counter-weights of double-hung windows.

1. Thermal value (R) of different types of glazing

Single glazing	0.88 to 1.04
Double glazing	1.04 to 2.00
Window with a storm-window	1.56 to 2.08
Triple glazing (2+1 window-panes)*	1.85 to 3.17
Triple glazing (sealed panes)	1.31 to 3.03
Canadian standards for new buildings (R 1.70 corresponds to double glazing with at least a 1/4 of an Inch air space. Inch. R 2.55 corresponds to triple glazing: sealed double glass and storm window or sealed triple glass)	1.70 to 2.55 (depends on the region considered)

* In general, triple glazing (sealed) is not installed on old windows; the required work costs proportionally more than the energy saving over double windows.

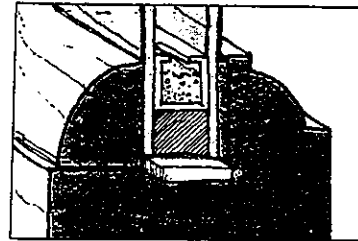

2. Sealed double thermal glass: The pane is placed on a neoprene cushion (between 1/8 and 1/4 inch [3-6mm] thick) and fixed to a wood strip. Even though it is relatively efficient, this type of pane is costly and fragile at the butyl joint.

A general principle of double-glazing is that the inside window should be more tightly sealed than the outside one. This is so that, during the winter, humidity in the inside air never reaches the cold outside glass where it would condense and rot out the wood. It is therefore often necessary to add ventilation holes (weep holes) from the air space between the two panes of glass to the outdoors. Drill slanted holes 1/16 inch or 1/8 inch (1.5 or 3mm) in diameter through the lower rail or lower stiles and treat them with preservative.

It is often possible to keep the existing glass and add a second pane. In the case of a multi-paned sash, a single pane can be installed over the whole sash or a new piece of glass over each pane.

The single new pane can be installed in mouldings screwed to the sash (ensuring that the screws do not interfere with the functioning of the window). Installing the new pane on the interior of double-hung windows facilitates maintenance.

It is possible to make the second pane out of lighter and cheaper materials than glass: acrylic and polycarbonate sheets. Unfortunately, these plastics scratch easily and become discoloured with time. Since it is lighter and less fragile than glass, plastic can be screwed directly onto the sash. To allow the material to work with the seasonal forces exerted on the wood, leave a little play around the screw holes.

Adding the double glass to each pane is more costly and can require the replacement of muntins if they are too small and weak for the extra thickness and weight. Double panes can be installed on the exterior by enlarging the original groove or on the interior by making a new groove in the turned mouldings. With multi-pane sashes, weep holes should be made from each of the separate panes.

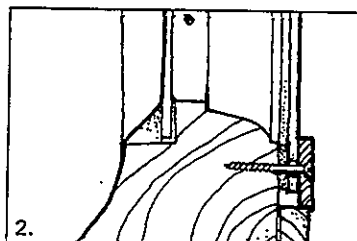
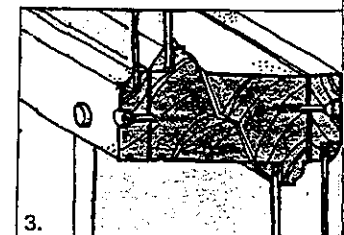
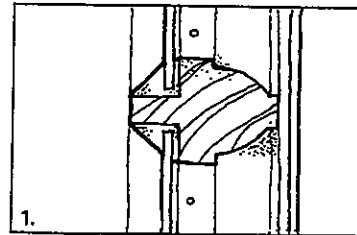

3. Addition of a second glazing:

1. clearance over muntins;
2. transparent plastic sheet screwed to the sash;
3. glass mounted on new moulding screwed into the existing sash.

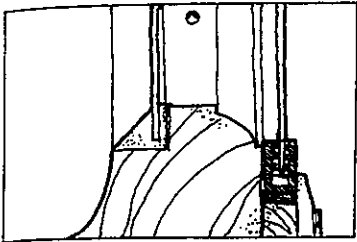

1. Second glazing in an independent frame: made of metal channels and held to the sash by either wood or plastic tabs or mounted on hooks.

It is sometimes possible to remove the existing single pane and replace it with factory-made thermal windows (thermopan). These are particularly effective in reducing heat loss caused by radiation and conduction. Again, the strength of the sash and muntin bars as well as the latter's depth must be checked to ensure that they can support the extra thickness and weight.

The two panes are separated by an aluminum frame sealed with butyl. Humidity between the panes is absorbed by crystals inside the frame. The distance between the two sheets of glass varies from a 1/4 inch to 1 inch (6 to 25mm). The usual spacing is 5/8 inch (15mm).

To install thermal windows, the sashes should first be checked to make sure they are rigid and square; since the butyl joint is fragile, movement of the sash can break it. The glass is placed on a layer of putty or on neoprene blocks. The joint should be carefully puttied and then painted to make sure that the butyl will not be destroyed by water infiltration.

It is also possible to install thermal glass temporarily which makes maintenance easier. Each piece of thermal glass has its own wooden or metal frame, which is attached to the sash with screws or strips of wood. In order to prevent heat loss, foam or rubber stripping is inserted between the frame and the glass.

Installing storm windows: Fixed or movable storm windows are the traditional way of doubling window glazing. They offer the same heat savings advantages as double-glazing within a single sash and have the same problems with condensation and maintenance.

Storm windows are generally easier to install than double-glazing since they are totally independent of the existing window. A pre-painted metal or wood frame is attached to the exterior window frame with hooks or screws. Unpainted metal (e.g. raw aluminum) is generally aesthetically unacceptable on older buildings. Storm windows are also available which are installed from the interior, either by magnetic or plastic strips.

Storm windows can repeat all of the window's divisions or only its principal ones.

2. Doubling of the glazing on the exterior of each pane by enlarging the groove:

This is a good solution for large windows or ones which do not have many divisions. The rails and muntins must be large and strong enough to support the extra width and weight.

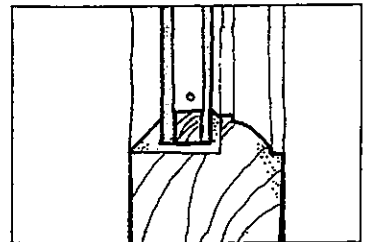
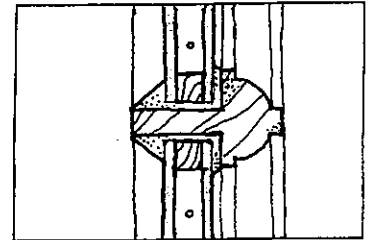

3. Second pane installed in a groove: the groove is routed on the interior face of the window, the glass is held by moulding.

Weep holes here are indispensable when any double window is added.

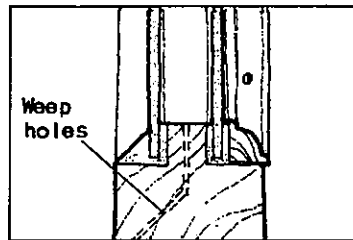

4. Hook to suspend the storm-window: It is advisable to install weather stripping on the frame or caulking on a seasonal basis.

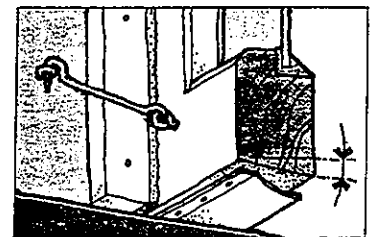

5. Lower rail of a double sash: The wood follows the slope of the window-sill. If the storm window is fixed it should be caulked, otherwise metal weather-stripping is added.

6. Replacement

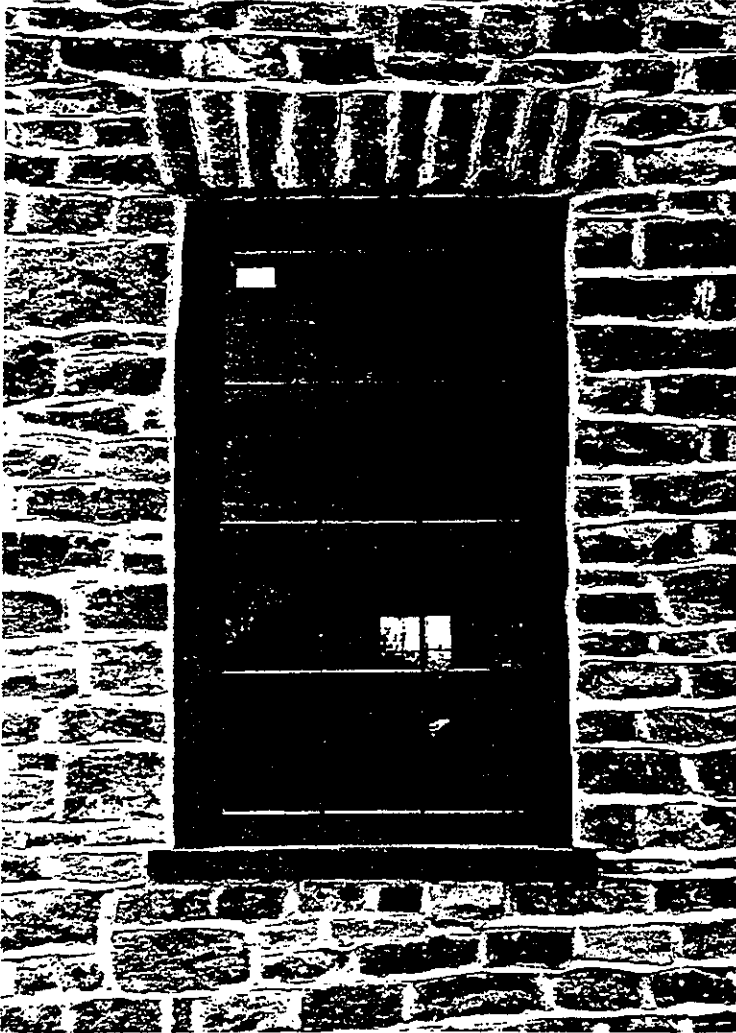

Just because some windows on a building are damaged does not mean that they all should be replaced. Total replacement is a last resort; yet it is often the only one considered.

Even if some windows are damaged beyond repair, it is possible to replace only the panes. Alternatively, it is possible to replace only the sashes (with exact copies) within the existing frames. Both alternatives can be less expensive than total replacement and avoid the difficult task, and inherent risk of choosing a new window.

However, if the decision is made to choose new windows, this chapter outlines some of the principle criteria for selecting an appropriate one. Along with cost and availability, one should also consider aesthetic and technical criteria.

Aesthetic criteria (section 6.1) deal with how well the replacement windows resemble the originals and how well they harmonize with the facade. **Modifying the window opening** is rarely acceptable because it alters the facade's proportions. From an aesthetic point of view, the best replacement window is an exact copy of the original. In some cases, a simplified version might be appropriate.

Technical criteria (section 6.2) should also be used to evaluate the various models available. These include durability, construction, maintenance, air infiltration, energy loss, ventilation, water infiltration, and condensation. There is a considerable variation in quality in the large variety of windows on the market so careful analysis is warranted before the decision is made.

6.1 Aesthetic criteria

A replacement window should match the original window as closely as possible in terms of: overall dimensions, method of operation, subdivisions, size and profile of frame, sash and muntins, depth within the facade of the building.

In buildings of particular architectural character or heritage value, especially those with multi-paned or other special windows, the replacements should be exact copies of the original.

In buildings of less historic value, variants might be acceptable as long as the resulting effect maintains the character of the facade. With row housing, greater change might be acceptable on the rear which cannot be seen from the street.

It is always safer to duplicate the original which was carefully designed to harmonize with the design of the building.

However if you are considering changing the window design, a careful and accurate drawing should be prepared beforehand to get an idea of the effect different options would have on the facade. It is advisable to consult an architect who is experienced in restoration.

If the original window no longer exists, it is possible to find out what it looked like through historical research or from similar buildings in the area. If the present, but not original, window harmonizes with the character of the building and it must be replaced, the new window could be a copy of the present window. If the present window has no value and there is no information on earlier windows, a harmonious, contemporary design is acceptable.

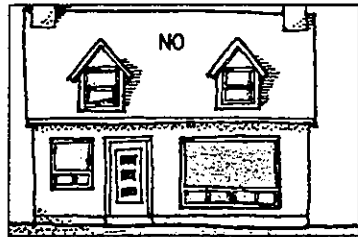
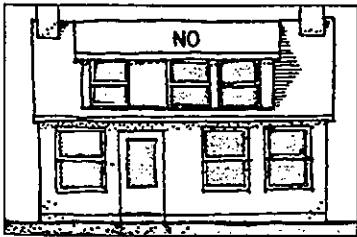

1. On old and recent buildings, the windows are designed to fit into the particular character of the building on which they are located with different shapes, (eg. vertical on old houses and horizontal on bungalows), sizes, types and details (two top drawings).

Taking a window from one building type and putting it on another results in a hodge-podge design which is neither new, nor old (bottom two drawings).

Large square or horizontal windows in a traditional building destroys the vertical lines and the character of the building.

Modifying the window opening

The window openings of the main facades of buildings with architectural character or heritage value should never be modified. Openings should not be enlarged or reduced to accommodate standard-size windows or new suspended ceilings and partitions.

In some older industrial buildings where little natural light is needed, windows are often partially or entirely bricked-up to reduce heat loss. It is possible to reduce heat loss while preserving the windows and the character of the building by adding dark-coloured, insulated panels inside the preserved windows.

There are some kinds of windows which should be avoided on older buildings. Windows of a style older than the building itself (such as replacing double-hung windows of a Victorian building with small-paned casement windows) are an historical and stylistic nonsense.

Similarly, modern windows which have no relation to traditional architecture (such as horizontal or square, suburban-style, "picture" windows over sliding sashes) should not be used.

The use of fake, "snap-in" muntin bars is also questionable. They are not only silly, they are ineffective because the reflection on the glass makes them virtually disappear anyway making it obvious that it is one large pane.

2. Reduction of opening: To install a standard window or to adapt it to a suspended ceiling in the interior is unacceptable.

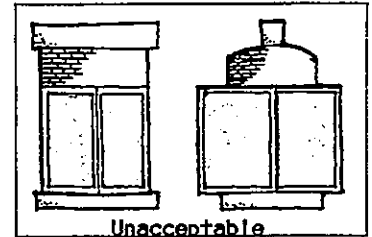

3. In order to preserve the appearance of the existing opening, suspended ceilings should rise above the height of the original, a short distance from the outside wall.

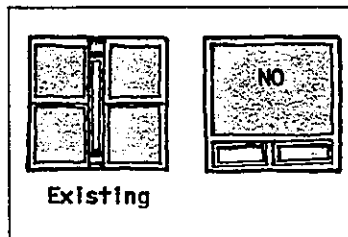
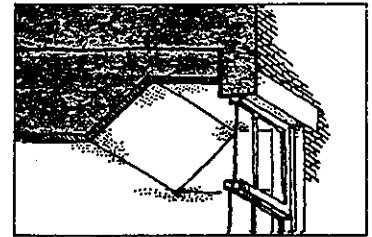







Existing

4. Traditionally, square openings were often divided into two vertical windows separated by a central post (mullion) in stone or wood decorated with mouldings. This type of division should always be preserved.

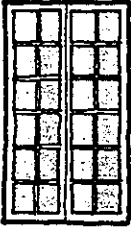
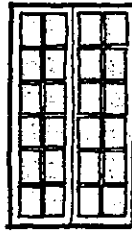
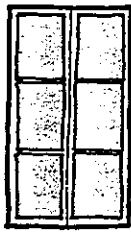
1. Choice of a replacement model for a traditional window

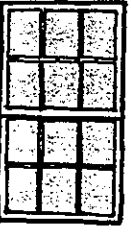
Footnotes:

1. These models might be acceptable on buildings of limited architectural character or heritage value.
2. Since this type of traditional window is generally found on buildings of great value, it should generally be replaced by an identical window.
3. These models are not suitable for older buildings.

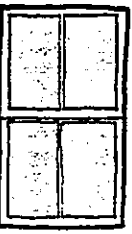
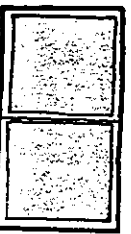
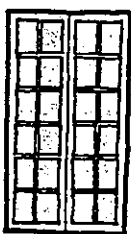
Original window	Preferred replacement (same model)	Similar or simplified model ^{1°}	Unacceptable replacement
 Casement Small-paned ²	 Casement Small-paned	 Casement Medium-paned	 Double-hung Large-paned NO
 Double-hung Small-paned	 Double-hung Small-paned	 Double-hung Large-paned	 Fixed glass and sliders ³ NO
 Double-hung Divided glass	 Double-hung Divided glass	 Double-hung Large-paned	 Casement Small-paned NO

2. Doors: The window opening in a door is a major determinant of its character.

For example, in some areas, during the 19th century and at the beginning of the 20th, an elongated pane occupied one to two-thirds of the doors in town houses. In the country, doors generally contained small square panes of glass, their number depending on the age of the house and corresponding to the style of the windows.

If doors must be replaced, it is best to do so with an exact copy of the original. If this is not possible, a simpler door which has a window opening of the traditional size and shape is preferable to an "old-fashioned" door from a catalogue which really has no relation with the architecture of the building or the area.

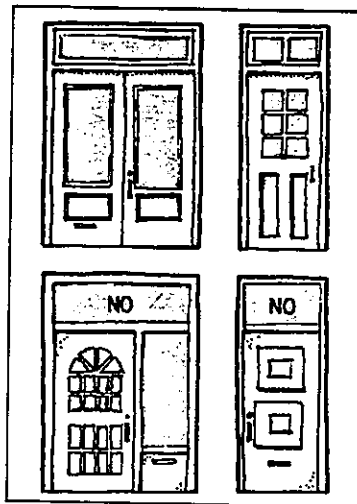

To preserve the character of a building:

1. Openings should not be modified.
2. All windows of a building or architectural "ensemble" should be treated the same way.
3. If the original window is still in place, the replacement window should be its exact replica.
(On buildings of very great historical value, it could even be made using traditional techniques. On buildings of limited interest, replacement by a simplified model[°] might be acceptable.)
4. If the present window is not the original, but still harmonizes with the character of the building, the replacement should be:
 - a replica of this window, or
 - a replica of the original window, or another window known to have been used on the building.
 (On buildings of limited interest, replacement by a simplified model[°] might be acceptable.)
5. If the present window is of mediocre quality and inappropriate for the building, the replacement window should be:
 - a replica of the original window, or another window known to have been used on the building, or
 - a simplified model[°].

[°] Simplified model: a window of composition inspired by the traditional model.

6.2 Technical criteria

Available models

There are a number of standard traditional windows on the market and it is also possible to have virtually any type of window made to order. The cost of these traditional windows is often not very expensive. They should always be considered first since from an aesthetic and historical viewpoint the best replacement model is always a copy of the original window.

In addition to exact reproductions, there is a large variety of windows made following the same principles as traditional windows but with slightly different details and sometimes using new materials (aluminum, steel or wood covered by metal or vinyl).

Today's double-hung windows use a different method for holding the window open. Instead of a system of counterweights and pulleys, steel springs or a friction fit is used. On some models, the sashes can also be tilted at an angle for cleaning.

Some new casement windows open to the exterior with the help of a crank. These usually have only one mobile casement or two casements separated by a post. Screens are installed from the interior.

Sliding windows became commonplace after the Second World War. The sashes slide horizontally, usually on nylon runners. These new models, generally made of metal, are not suitable as replacement windows on traditional buildings.

Windows are graded according to air infiltration, thermal resistance, manoeuvrability, and the ability to withstand weight. The best quality is GPL.

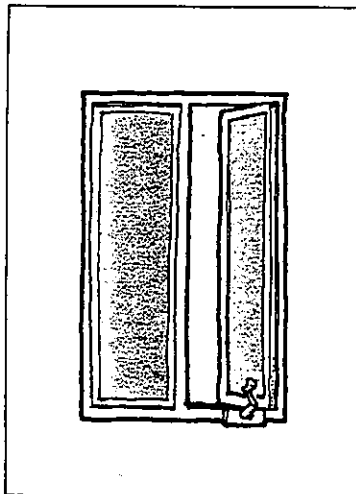

2. Casement window:
Operated with a crank and
opening to the exterior.

1. Durability

The durability of a window depends on its construction and maintenance. It can be evaluated by the quality of its materials and their protection (paint) as well as the quality of assembly and the operating mechanism.

In general, a new window will operate without any difficulty for the first few years. The problem is that, when it starts to break down, it may be very difficult to repair. Whereas almost anyone can make wood repairs at low cost and the simplest of tools, metal and plastic repairs are much more difficult.

More serious are problems with complex operating mechanisms. When they break down, as they inevitably do, they are difficult to repair, especially if this style is no longer made or the manufacturer has gone out of business. For this reason, it is advisable to choose simple mechanisms and well-known manufacturers.

Double-hung windows which use the sashes to counterbalance each other are the simplest and usually the least susceptible to damage.

Casement windows which open to the interior cause structural stress on the frame; the hinges will require regular adjustment. Crank mechanisms get easily out of alignment.

It is essential that wood windows have a surface protection such as paint or opaque stain (see pages 31-33) or else they will deteriorate very quickly due to exposure to the sun and other elements.

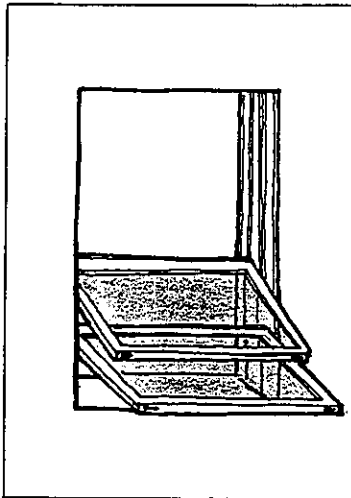

1. Double-hung window
with a mechanism which
permits the sashes to tilt
at an angle to make cleaning
easier.

2. Manoeuverability

Metal double-hung windows are generally easy to operate when they are equipped with a balancing system (counter-weights, spring-loaded tape). The size of the sash also affects its ability to function. Spring-loaded mechanisms often jam, especially in winter when they freeze.

Traditional casement windows are sometimes difficult to shut. Models which open with the help of a crank are delicate. The mechanism can clog, blocking the sash and making it necessary to dismantle and clean the gears.

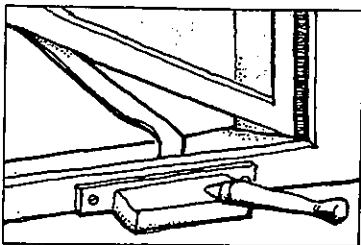

1. **Crank mechanism for casement windows opening toward the exterior:** The crank permits variable degrees of opening but requires good maintenance. Since it is exposed to the elements, it can be damaged by a gust of wind to an open sash.

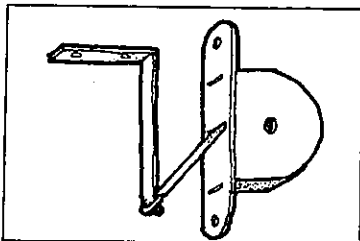

2. **Spring-loaded tape mechanism:** This system can be used to replace the old counterweight and pulley system of a double-hung window.

The tape is hooked onto a piece attached to the upper rail of the sash.

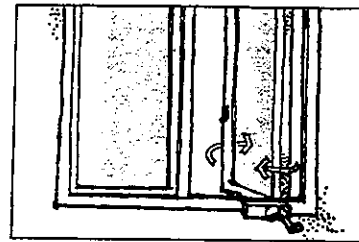

3. **Casement window opening toward the exterior:** It pivots in order to clean exterior. Inward-opening casements expose both sides of the glass.

3. Maintenance

In evaluating how much maintenance a new window might need, the operating mechanism and other moving parts as well as the materials should be analyzed as well as how easy it is to clean. The necessary work varies depending on the complexity of the window. Wood needs the greatest amount of maintenance, which is primarily the regular application of paint or stain.

Double-hung windows with a sophisticated balance system require regular adjustments. It is also necessary to maintain the slides to avoid unnecessary friction. Cleaning sash windows is easier with the new system in which the sashes can be tilted to the inside or removed (page 49, fig.2).

Older casement windows offer the most advantages since they only require adjustments of the closing joints and hinges. The recent crank models are more delicate. They open to the exterior which makes them susceptible to water infiltration into the mechanism, and to damage caused by strong winds. When it comes to cleaning some of these windows are equipped with a sliding mechanism which pivots the window toward the interior (see fig.3).

4. Air infiltration

The installation of new sealed windows, (or the improvement of old windows,) can cut heating costs by 15% to 20%; more in townhouses where air escape contributes to a higher proportion of heat loss.

A certain amount of air circulation (one air change every three hours) is needed to ensure fresh air and prevent build-up of fumes (odours and gases released by cooking and construction materials, such as insulation, and paint) so there is no point in attempting to totally seal a building unless there is an alternate circulation system (eg. fresh air intake with heat exchangers).

All mobile parts of a window allow air infiltration but the amount that penetrates depends on the quality of the joint between the frame and the sash. The standard varies between 0.5 and 0.75 cubic feet per linear foot per minute and the majority of the models comply to the norm of 0.5. (This compares to a loss of up to 2 cubic feet per linear foot per minute [0.19 m³/m/min] from a poorly fitting old window). This performance is obtained through the use of various kinds of weather-stripping integrated into the frame and sash.

Double-hung windows are inherently somewhat less efficient because the weather-stripping cannot be completely tight to allow movement of the sashes in the slides. Casement windows have the advantage of having the weather-stripping compress when the casements are closed.

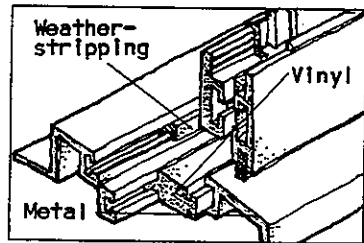

1. Thermal break in a metal window: The pieces of metal are separated with polyurethane or vinyl.

5. Ventilation

The degree to which a given window ventilates effectively depends on how much of the total window opens, and how easy it is to keep the window partially open.

Double-hung windows cannot open for more than half of their surface area. They can be easily held open to any position. Those which are open at both the top and the bottom create a natural convection current which evacuates and replaces interior air. Windows where the top sash counterbalances the bottom one have the advantage of automatically opening this way.

Traditional casement windows open up entirely which is an advantage on hot summer days. However, they offer little choice as to the angles at which they can be kept open. Current models with cranking mechanisms have greater flexibility but generally do not open quite as wide.

6. Energy loss

In most of Canada, the use of double windows (double-glazing or storm windows) is now an accepted standard for energy conservation and virtually all new windows in this country have two layers of glass. Adding a third layer of glass (sometimes detachable) is not usually cost-efficient in Southern Canada unless the building is already extremely energy efficient. It is advisable in Northern Canada.

The window frame also constitutes an important thermal bridge. Wood offers greater thermal resistance than plastic or metal. Since metal is an excellent thermal conductor, all contact between the interior and exterior in a metal frame is avoided by separating the inner and outer components of the frame with vinyl strips or by injecting polyurethane and by weather-stripping between the sash and the frame (see fig.1).

7. Water infiltration

Windows must be watertight in order prevent water from entering the building and to avoid deterioration of the sill and wall.

The majority of new windows conform to the normal standards of water tightness. Construction details play an important role here: drip moulding on the bottom rail of a casement, sill inclined at least 10°, tight joints especially at the bottom of the window and frame.

Water infiltration often takes place when casement windows are open. This is less of a problem with double-hung windows which have adjustable openings.

8. Condensation

Condensation and frost affect windows by limiting the passage of light and damaging materials and their finishings. In a cold climate like Canada's, condensation usually occurs in the winter, when moist, interior air meets a cold surface. This is almost inevitable, especially if there is only a single pane of glass.

Condensation can be avoided by double glazing or adding storm windows. The interior pane should be more watertight than the exterior. Vent the exterior pane or sash by using small weepholes, except in the case of thermal glass.

7. Accessories and special forms



A number of different accessories are used to allow a window to carry out its various roles.

If there are such elements on a building which dates from the original construction or fit in well with its character, they should generally be preserved. The decision to install new accessories should be taken carefully since they can change the operation of the window and have a considerable aesthetic impact on the building.

Interior shutters (section 7.1) can be directly mounted on the window frame or be fitted into the cavity on the sides of the interior bay. Shutters protect against light and cold, a function also performed by modern **insulating shutters**.

On the exterior of a building, louvered shutters, blinds and **awnings** (section 7.2) protect against the light and have some effect on heat conservation.

Storm windows (section 7.3) conserve heat and eliminate condensation. New storm windows should be compatible with the windows already in place and harmonize with the proportions of the building.

Security devices (section 7.4), grills or screens, have been used traditionally, particularly on rural and institutional buildings, and are of growing interest in today's society.

This chapter also deals with cousins of the window, **skylights and dormer windows** (section 7.5), and **greenhouses or sunrooms** (section 7.6). They all fulfill some of the prime functions of the window: lighting, view to the exterior, and protection against the elements.

7.1 Shutters

Traditionally, shutters were used to protect windows from the elements and to shut out light. They should be kept closed at night in the winter to cut the wind, stop heat loss through radiation and trap an insulating layer of air between the shutter and the window. In the summer, they should be closed during the day to block sun's rays.

In the past fifty years, their role has been increasingly limited to decoration, so much so that in the past decades, fixed false shutters have come into fashion.

Shutters can be solid or louvered, and installed inside or outside.

Shutters are made of joined panels assembled like traditional door and often made of pine. In Canada's early days, shutters were often the only way of closing the window. With the widespread use of glass their role was limited to shutting out light and protecting ground floor windows during the night.

Older interior models are made of two casements joined to the window frame and opening in the embrasure. During the Victorian era, shutters were made of a number of panels which folded back and forth like an accordion. These folding shutters fit into a pocket on the interior of the embrasure.

During the 19th century, a variety of interior louvered shutters appeared some of combined louvers with folding shutters.

Storm shutters were generally installed on the exterior window frame or on the masonry with wrought iron hinges. Made up of one or two casements, they protect the window from the elements or from breakage. They close into a groove on the frame and lintel or directly over the frame.

Louvered shutters (more properly called blinds) were installed for the summer, replacing the storm windows which were only used during the colder months. They are made up of a frame with either movable or fixed slats which serve as blinds protecting against light and providing ventilation.

The use of louvered shutters dates to the 18th century but did not become widespread until the 19th century. Louvers were sometimes mounted on their own frame on the exterior of a window. The lower rail would be elevated for water drainage. They could also be mounted on storm window hinges.

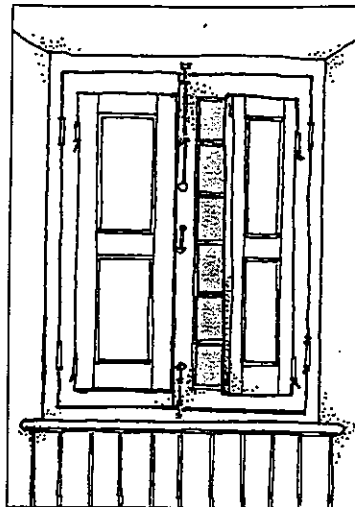

1. Interior shutters: made of wood panels mounted directly on the casements.

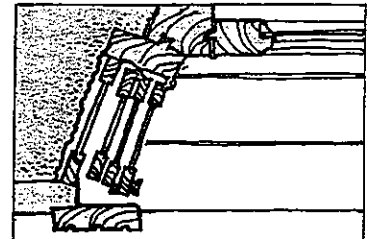

2. Interior shutters: made of a number of panels, folding into a box in the embrasure.

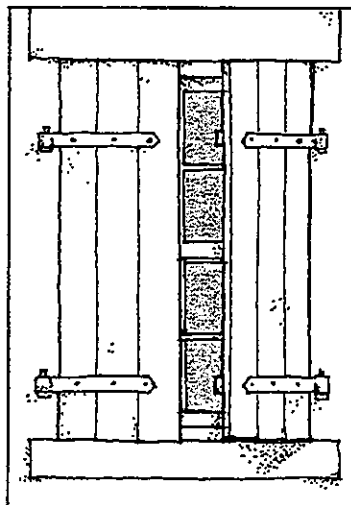

3. Storm shutters: made of boards, mounted on wrought iron hinges sealed into the masonry.

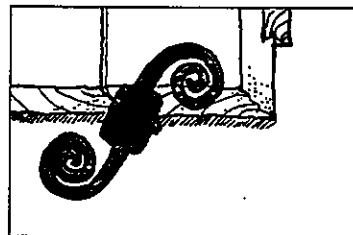

4. Cast-iron S-hook used to hold the storm shutters open.

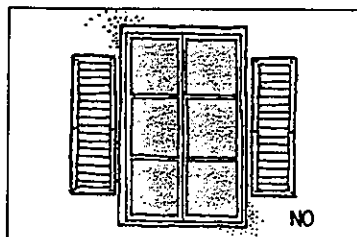

5. False shutters: Accessories which do not even look like they could work are inappropriate.



Insulating shutters

Window insulation can be improved through the use of insulating shutters. Typically, they are made of rigid insulation backed by a sheet of reflecting aluminum and set between two pieces of plywood on a wood frame. The sides of the shutters are grooved to receive weather-stripping and provide a tight seal.

One drawback to these shutters is that they can damage the wood of the window by trapping moist air which condenses on the window sill or sash as the temperature drops during a cold night. Therefore, evacuation of humidity or condensation to the outside must be provided for.

1. Lower shutters (blinds)

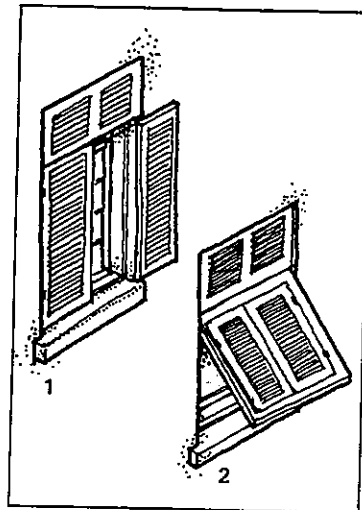

2. Lower shutters:
1. double shutters (the most common type) used on double-hung and casement windows.
 2. awning louvers, used mostly for double-hung windows.

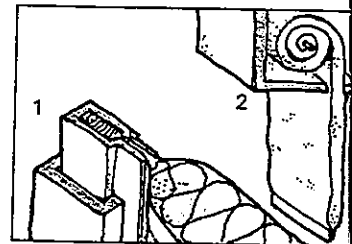

4. Insulating blind:
1. Groove in which the blind slides to insulate the window.
 2. Containing box over the window.

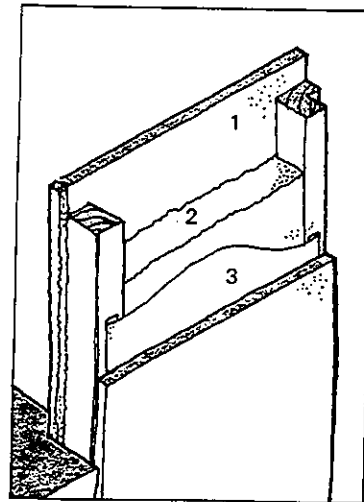

3. Elements of an insulating shutter
- From the outside in:
1. Frame and panels of wood;
 2. Insulation;
 3. Aluminum foil reflecting to the interior.

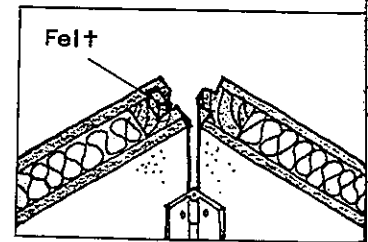

5. Folding shutters: Joint between two panels is sealed by an interlocking joint.

7.2 Awnings

Awnings are another subtle and sophisticated device used since the late 19th century, primarily to provide protection from the sun and rain.

While shutters were used principally on residential buildings, awnings tend to be used largely on commercial buildings and particularly on storefronts. Like shutters, there is a recent tendency to forget what an awning was really for and to use it for purely decorative purposes.

Most awnings are rolled up with a crank mechanism although some systems use ropes and pulleys.

Since they are lightweight, essentially temporary structures, they require a fair amount of maintenance. A canvas covering will probably need to be replaced every four to six years, (perhaps a bit longer if it is laminated with plastic). The structure, mechanism and covering are subject to damage in strong winds.

Installation of awnings is not necessarily appropriate for every style of architecture. For example, they are more appropriate to a Victorian office building or mansion than an 1825 farmhouse. In general, the form of awnings should relate to the shape of the opening. On upper floors, they should fit within the opening itself. They should be installed in such a way that no architectural features of the building are obscured.

The use of modern fixed awnings in aluminum or plastic should be avoided in older buildings because they harmonize poorly with the building and permanently obstruct the window opening. Backlit signs in the shape of awnings should also be avoided.



2. Awnings on a 19th century commercial building

1. Retractable awning over store window

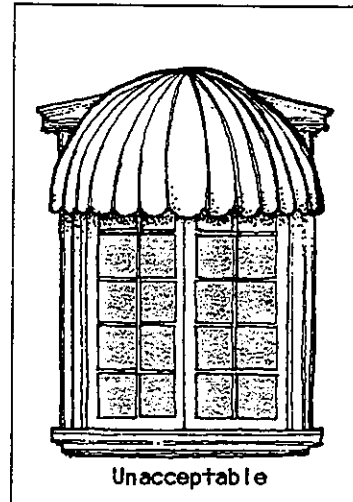
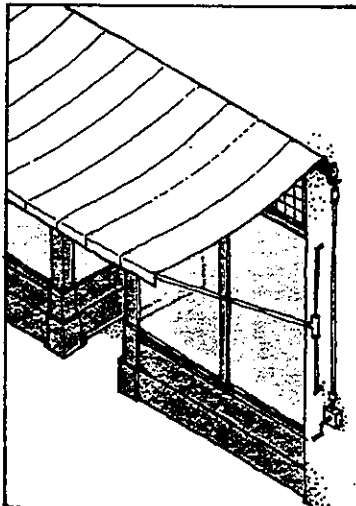

3. The installation of a new awning over an older building should respect the shape of the opening, and not obscure the architectural details of the building.

New awnings should not be added to a building type which never had this type of accessory.

7.3 Storm windows

Storm windows (commonly called double windows) have been used for centuries as an accessory to window to reduce heat loss as well as condensation and frost on the interior window. Like windows themselves, they have undergone diverse transformations.

History

Storm shutters fulfilled the function of storm windows until the middle of the 17th century. The first storm windows were two mobile sashes fixed to the frame of the casement and opening towards the exterior. The next development was a fixed storm window of one sash that was held in place by hooks.

The storm sash duplicated the form of the interior window with a slightly larger lower rail to accommodate the slope of the sill, and still have the muntin bars line up exactly with the interior sash. (See page 57, fig.2)

Sometimes, a storm sash does not match its mate because it deteriorated before the main window and was replaced with either a new model or one salvaged from another building.

Installation and ventilation

Fixed storm windows were originally nailed directly to the frame of the window. Soon they were attached by hooks to the interior frame. In some models, the upper rail was fixed to the lintel by dowels.

Later models had the storm window inserted in a groove in the frame which was used in the summer for screens or louvered shutters. Rags or oakum were used for temporary caulking when the storm windows were put on each fall.

These fixed storm windows did not allow ventilation during the winter. Therefore, air holes which could be blocked by a rotating or sliding wood slat were often pierced through the lower rail and sometimes one of the panes was openable. Towards the end of the 19th century, metal fans were sometimes installed directly into the window.

By the mid-19th century, the storm windows were usually a second set of regular windows, either double-hung or casement. There could be double-hung interior windows with casement storm windows or vice versa, or two sets of double-hung. Although the second sets of windows were designed to be removed in the summer, they were often left in place for the entire year.

A typical installation had two pairs of casement storm windows attached with cast iron hinges to a frame divided by a fixed cross-bar. Again, the same frame and hinges were used in the summer for screens or louvered shutters. The hinges were bevelled to allow the sashes to be adjusted to varying positions.

Interior casement storm windows were often mounted into the frame by using dowels or hooks in the jamb and header of the frame. They could easily be taken down for cleaning.

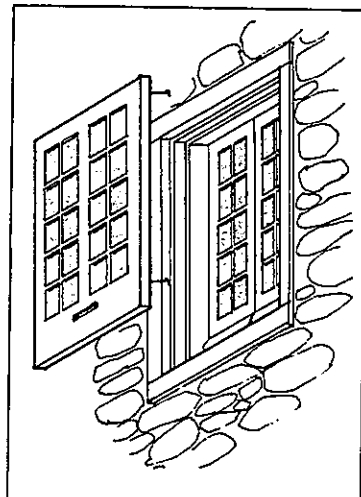

1. Storm window: The sash is fixed to the frame by hooks, and its muntins follow the divisions of the main window.

New Storm Windows

It takes some effort to install and remove storm windows every year. Often they were left in place all year which accelerated their deterioration and permanently obstructed the view.

As a result, metal, exterior double windows which integrated storm windows and screens have largely replaced traditional storm windows. Usually, they are made out of aluminum and are screwed to the exterior frame.

These windows pose certain technical problems. Often, they simply do not operate very well; they have fragile frames, get stuck easily and the closing mechanisms often jam. Directly attaching the metal frame to the window's wood frame and sill inhibits the evacuation of condensation and other moisture. Good weatherstripping and weep-hole in the aluminum frame can solve the problems but the presence of metal will continue to lead to condensation.

The use of metal storm windows on a traditional building can have a very negative effect on its character and is not recommended. This is especially true for multi-paned windows because the large glazed surface of the modern metal double window, often mounted flush with the outside wall, and its narrow metal framing, obscure the details of the original window.

It is preferable from many points of view to repair existing storm windows (see chapter 5, Repairs) or to install new ones (see page 45) following the main lines of the composition of the main window.

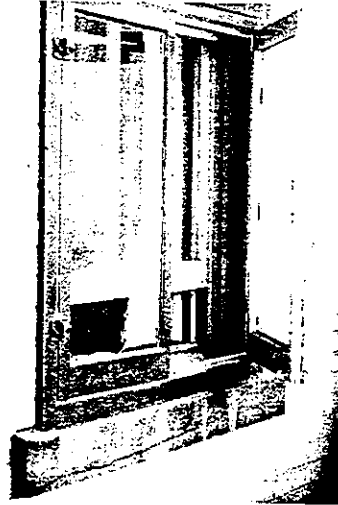

3. Casement storms on a double-hung window

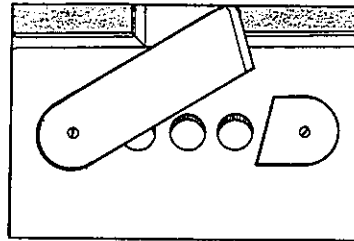

4. Storm window ventilation holes: They are drilled into the lower rail and closed by a wooden slat.

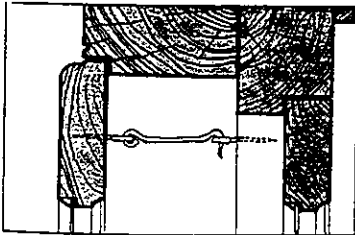

1. Installation of a storm window: Placed on the outside of the frame, the storm window often overlaps the outside wall; the upper rail is bevelled to prevent water accumulation.

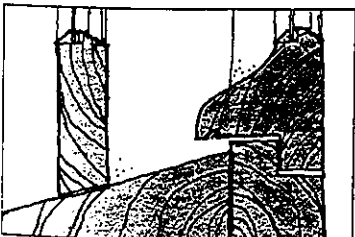

2. Lower rail of a storm window: It is larger than the lower rail of the interior window to accommodate the slope of the sill and allow the divisions to be at the same level as the interior window.

7.4 Security devices

1. Double-hung window locked with a long nail or metal rod

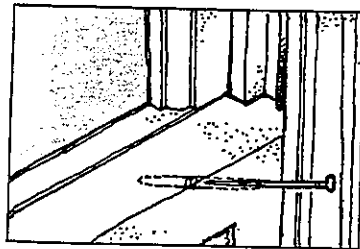

2. Piece of wood inserted behind the sash cord to block window movement

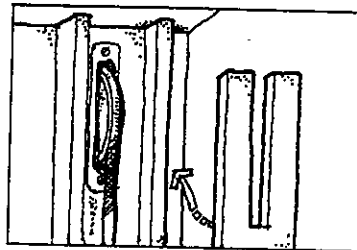

3. Latch fixed to the sash: Allows the window to be locked to corresponding positions on a metal plate.

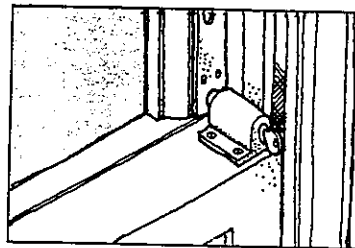

The two principal ways of making a window more secure are installing bars in the opening (fixing them into the masonry or frame) and adding security devices to the window itself.

Grills are a traditional solution to the problem of security, found mainly on farm and institutional buildings (residential buildings were more likely to have shutters on the ground floor).

Installing grills or bars can easily be done by placing plugs in the masonry (which are large enough to let the metal expand and even rusting without cracking the masonry). This work should probably be left to either a mason or a metalworker. The design of new grills should relate to that of the window and the building. Although grills are quite effective, they do obstruct the view.

As an alternative, the window can be reinforced with the aid of hardware such as latches and locks. The glass remains the weak point. It can be replaced or reinforced with plexiglass sheets (although they have a tendency to yellow with age) or be equipped with an unobtrusive alarm system.

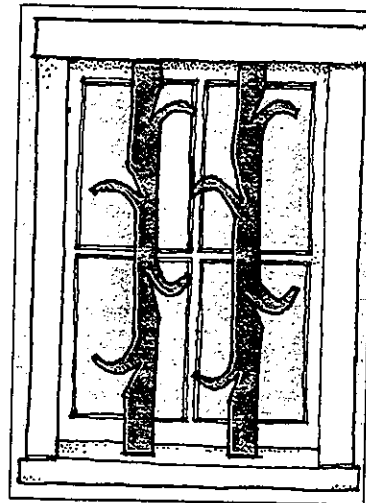

4. Decorative metal grill work designed to prevent entry

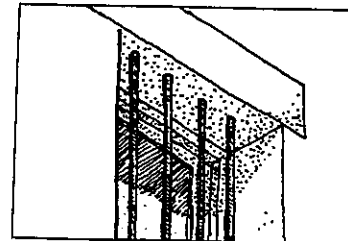

5. Iron bars running into plugs in the masonry

7.5 Skylights and dormer windows

Skylights and lightwells have been used since the end of the 19th century, mainly in urban areas. They add natural light to the center of a building and are often found in service areas such as stairways and bathrooms, sometimes spanning two rooms. Besides bringing in natural light, skylights produce a chimney effect which creates some ventilation (see page 8).

Traditionally, skylights are composed of three parts: the glass and metal structure on the roof, the shaft and a glass sash near the bottom which reduces heat loss. The shaft can often be lifted by a cord for ventilation. It is made of wood or metal depending on its use — residential or industrial — and its dimensions. Often the glass is frosted to diffuse the light.

The shaft goes from the ceiling of the top floor to the roof and is finished in either wood or plaster. The shaft is constructed between the ceiling joists or, if it is large, one of the joists is cut out and the framing reinforced.

Traditional skylights were made in the shape of a pyramid on a low parapet, with metal posts supporting the glass. The center of the stack was generally capped with a ventilation stack. Skylights of this design are still produced.

Modern skylights are generally made out of two sheets of curved plastic. This design has the advantage of being a double glazing which covers the opening without obstructing it. However, most new models do not possess any ventilation systems. This can cause condensation problems. Both traditional and modern skylights are equipped with gutters to collect moisture and allow it to evaporate.

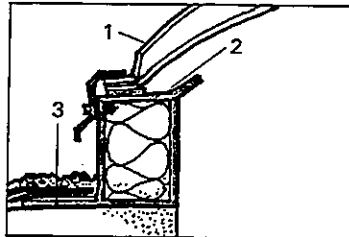
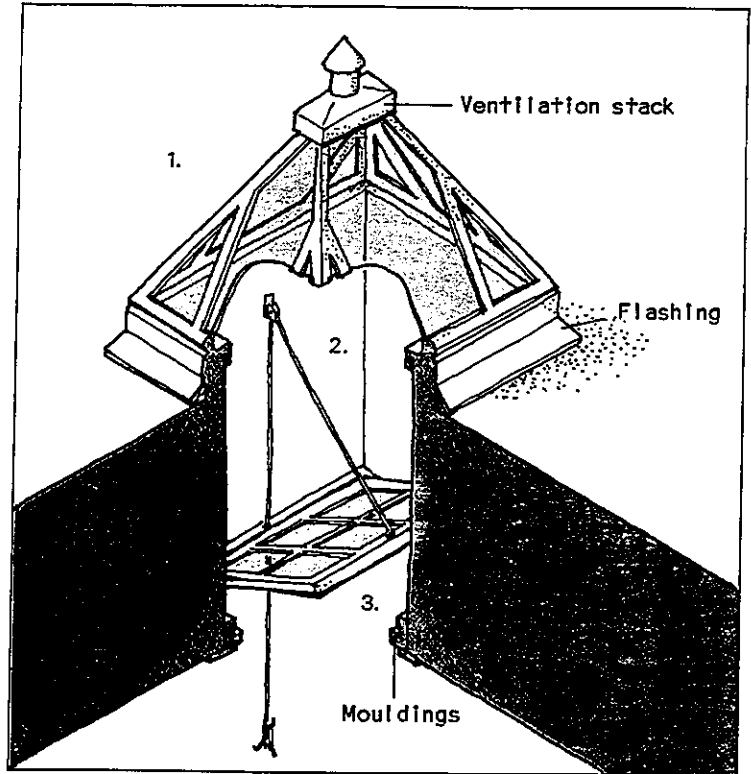

2. Traditional skylight and lightwell:

1. Skylight and ventilation stack;
2. Shaft cut through the roof and finished in wood or plaster (wood resists variations in temperature and humidity better than plaster);
3. Sash designed to prevent cold air infiltration. The glass is sometimes frosted or etched in order to diffuse the light.

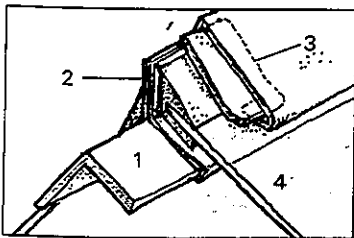

1. Sections of two types of skylight members: These alternate types are differentiated by the way the metal cover is attached to the member.

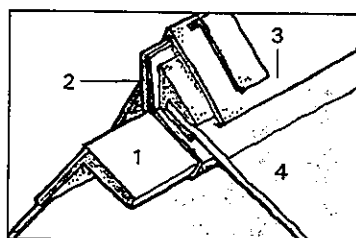

1. Iron structural post;
2. Sheet metal folded over the post carrying the tongues which hold the cover;
3. Galvanized metal cover;
4. Pane and putty.

3. Prefabricated skylight:

1. Doubled plastic curved glazing.
2. Gutter used to collect condensation.
3. Integrated flashing.

Technical problems

Leaks in skylights are usually caused by deterioration of putty, metal posts, ventilators, or flashing (see page 59, fig.2). The flashing on the glass supports can be bent back and then the glass puttied in the same way as in other windows. In some cases, it is possible to replace or simply reinforce some of the structural posts. If the posts and the vent are badly deteriorated, the whole skylight might have to be replaced.

The parapet flashing can usually be easily repaired by removing the gravel, then applying roofing cement to the cracks in the flashing. Next, roofing paper is placed over the cement and covered with more cement. Then the gravel is replaced.

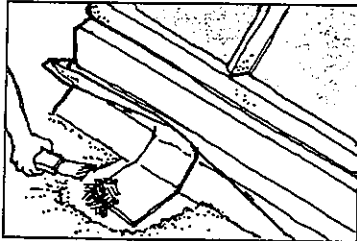
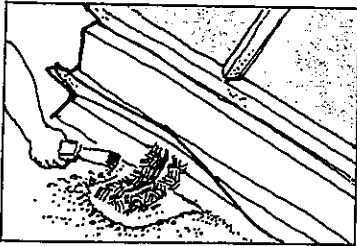

1. **Repairing flashing:**
 1. Lift the upper flashing and apply the first coat of roofing cement on the damaged portion.
 2. Apply roofing paper.
 3. Apply second coat of roofing cement.
 4. Lower or replace the upper flashing and cover the exposed areas with gravel.

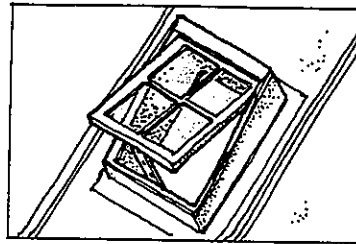

2. Traditional hinged skylight

Hinged skylights

On sloped roofs, a rectangular opening can be covered with a fixed or openable sash. Although rarely found in traditional architecture, the hinged skylight might, in certain circumstances, be acceptable from an aesthetic point of view. As with other skylights, the hinged skylight (or roof window) is mounted on a small parapet provided with flashing. Care must be taken to prevent water infiltration, especially at the upper part.

Flashing can be integrated into the frame of the skylight. Some hinged skylights come complete with flashing, otherwise galvanized steel or aluminum sheets are added. Lateral flashing is slid under the roofing membrane, or under each row of slate or shingles.

Preparation for the installation of a skylight takes three steps: preparing the roof (by removing the membrane, determining the exact location of the opening, shoring the roof from the inside); cutting the decking, the structure and ceiling; reinforcing the roof joists doubling the rafters). Then the actual installation takes place.

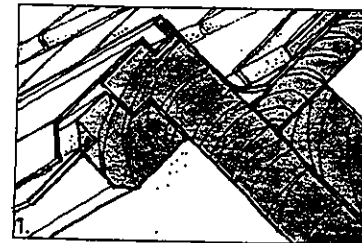
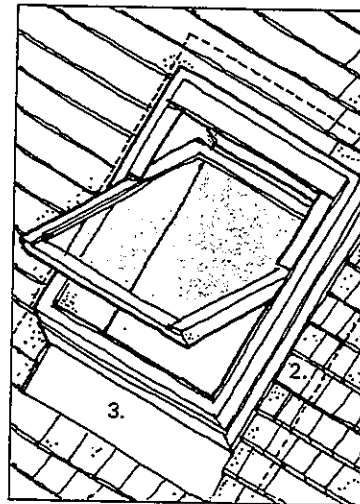

3. **Modern flat skylight:** Also called a roof window, this horizontally-hinged skylight is used mainly in residential architecture.
 1. Lintel flashing going from under the roofing membrane to the glazing.
 2. On the sides, pleated flashing goes under each row of shingles.
 3. At the bottom, the flashing goes over the shingles.

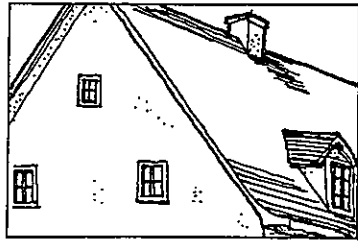

1. Gable windows providing light to the attic.

Dormers

While dormers are associated with the roof rather than with the facade, they, like other windows, have an important effect on the appearance of a building. Originally, dormers were used for access: to hoist goods up to the attic of a building. They also provided light to the attic which served to make them habitable although other forms of flat windows in a gable provided light without the extensive carpentry required for a dormer.

The form of the dormer has evolved parallel to that of the roof. During the Victorian period it took on elaborate shapes and forms. The introduction of the false-mansard roof at the end of the 19th century reduced the volume of the dormer window which became a simple frame around top floor windows.

The window of the dormer has followed the evolution of other windows. Its dimensions are usually smaller than that of other windows (often for aesthetic reasons) in which case it may have fewer panes than other windows.

Dormer windows follow the general form of a building. Even if added later or placed in another plane than the one of the wall, they were traditionally positioned in relation to the windows of the facade, either following their pattern or attempting to correct their asymmetry. Sometimes the front of the dormer window was simply a vertical extension of the exterior walls, becoming an integral part of the facade.

In terms of maintenance, repair and replacement, a dormer is essentially a window in a roof structure. Concerns with the window are covered in other sections of this guide. For further information on roofing problems and solutions, readers are referred to the technical guide in this series on roof coverings.

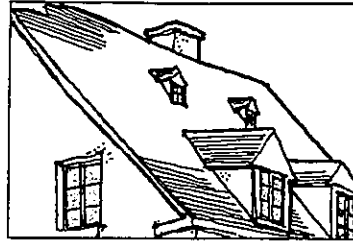

2. Two types of dormers employed for two purposes: The higher ones light the storage space and the lower ones, the inhabited space.

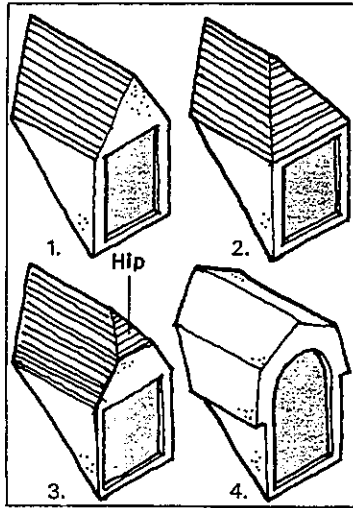

3. Different kinds of dormers:
 1. Projecting dormer;
 2. Hipped dormer;
 3. Jerkenhead dormer;
 4. Mansard dormer (which can also be curved).

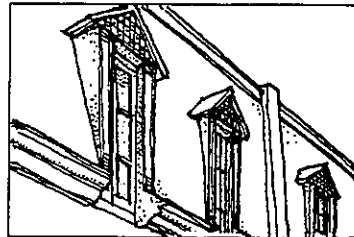

4. False mansard dormer: This dormer is purely ornamental.

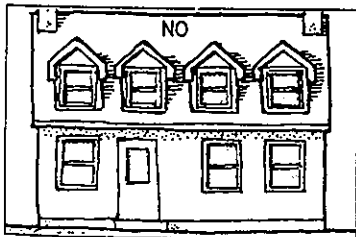

5. New dormer construction on older buildings should respect the buildings proportions.

1. Facade with too many dormers.
2. Shed dormer, which is too large and destroys the facade's proportions.

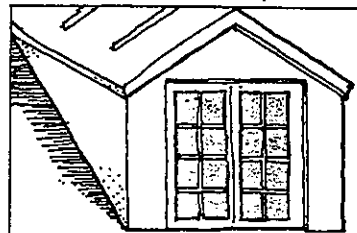
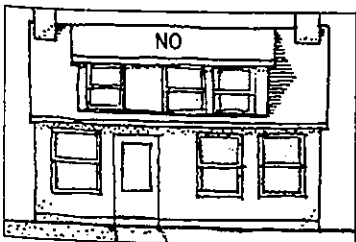

6. A dormer which has been insulated from the exterior. Because of this, the original proportions have been destroyed.

Integration of new greenhouses and sunrooms

While the design of these 19th century additions may not correspond to that of the original building, if they are traditional and harmonize with the building, they should be conserved. (However, their existence should not be used as an argument for adding incongruous new additions since modern construction techniques and architectural styles are so dramatically different from traditional methods.)

Building a new addition of this type is not appropriate for certain kinds of buildings and is too radical a transformation to be acceptable on buildings of particular historic importance. However, they might be acceptable on certain buildings for which there is an established local tradition for having this type of space. In this case, careful historical research and an examination of sunrooms added to other buildings of the same style in the region can serve as inspiration, or they can even be copied.

The design of a new greenhouse or sunroom, as with any other addition, can have a dramatic effect on the character of the building. It should be designed by a professional to suit the building in question and carefully considered — not quickly picked out of a catalogue.

Greenhouses are generally made of relatively large panes of glass. They suit larger 19th century residences rather than earlier, small houses. For the latter, the best solution may be to close-in the galleries with window frames. However, it is important to consider the effect of such an addition on the building as a whole, taking into account the scale, the materials, and especially the glazing which, although transparent, still reflects light and is therefore very visible.



2. Glazed urban balcony: The form, materials and design should be treated in a manner to harmonize with the building.



1. Sunroom made by enclosing a veranda: These sunrooms are usually made out of wood and built directly onto the gallery which is sometimes reinforced.

7.6 Greenhouses and sunrooms



1. Greenhouse of a Montreal residence at the turn of the century.

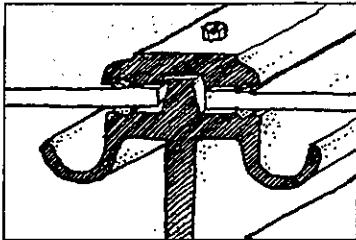

2. Cast iron greenhouse muntins with integrated drainage canals (from the turn of the century).

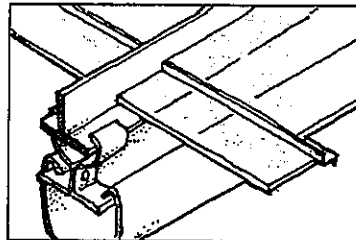

3. Gutter attached to an iron bar: The point at which glass plates overlap is reinforced by a folded metal strip which is sometimes pierced by weepholes.

Glass has traditionally been used to enclose interior spaces and protect them from the weather yet leaving them very open to the view and to light.

In the 17th and 18th centuries, precursors to the sunrooms appeared in the form of large glazed openings. Greenhouses and other glass structures became fashionable in Europe early in the 1800's, finding their way into larger Canadian homes, and public greenhouses later in that century.

Made of glass fixed to wood or cast iron members, greenhouses often had quite complex shapes. Residential greenhouses often had richly ornamented cast-iron members compared to commercial or industrial glass structures used for increasing illumination.

Many construction techniques evolved during the 19th and 20th centuries, designed to solve the problems of water tightness and condensation caused by vast areas of cold surfaces. Putty or rubber strips were used to seal the glazing. Pieces of glass (sometimes reinforced), were overlapped like shingles, placed in separate grooves like an ordinary window, or held in place by any one of a variety of interlocking joint systems.

Condensation produced by the vast cold surfaces of the glass flowed down the joining members which often incorporated channels that led to a drain.

In both urban and rural residential buildings, one finds a variation of the greenhouse, the sunroom. Often, these were spaces that were originally built as balconies or veranda and were later closed in by replacing the railing with a low wall on which a frame was erected to hold the windows. Unlike greenhouses, their function varied with the seasons: during the summer the windows would be removed and screens placed in the frames.

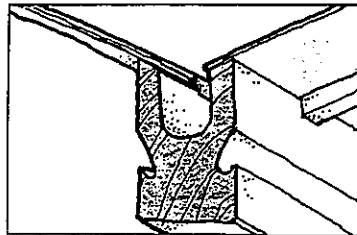

4. Construction of a wooden greenhouse rafter: The rafter is moulded on top to provide a rain gutter and the sides of the bottom are grooved to provide a condensation drainage gutter.

Index

- Aesthetics, 4-5, 9, 47-48
 see also "architecture"
 air leaks, 8, 18, 20, 25-27, 42-43, 50
 anchoring, 38
 see also "sealing hook"
 architectural value, 4-5
 architecture, 4-5, 9, 17, 47-48, 61, 63
- Bolt, 21
- Casement window, 4, 17, 20-21, 24-25, 33, 36-38, 41, 48-51, 53, 56-57
 caulking, 24, 35, 42
 products, 14
 casement, 7, 20-21, 27, 33, 36-38
 closing system, 19, 21, 22-23, 25, 41, 44, 49, 58
 condensation, 8, 25, 44-45, 51, 56
 costs evaluation, 29
 counterweight system, 18-19, 25, 41, 49-51
- Dormer, 61
 double-hung window, 4, 17, 18-19, 24-25, 33, 36-38, 41, 48, 49-51, 53, 56-57
 drip moulding, 21, 26, 37
- Epoxy, 35-38, 39
- Fixed sash windows, 22
 flashing, 27, 60
- Glass, 12-13, 31, 40, 59
 etching, 13
 size of panes, 18, 20
 stained, 13
 glazing, 8, 17, 22-23, 25, 58, 62
 repair, 40
 thermal value, 44-45
 greenhouse, 62-63
 grill, 58
- Hardware, 14, 19, 21, 22-23, 24, 43, 49-51, 58
 repair, 41
 hinge, 14, 19, 26, 41
- Inspection, 25-27
- Lighting, 8, 22-23, 31, 53, 55, 59-61, 62-63
 lock, 58
 louvered shutters, 8, 26, 53
- Metal, 14
 metal windows, 14, 17, 22-23
 mouldings, 37, 39
 reproduction of, 11
- Paint, 15
 application, 31-33
 colours, 15, 33
 deterioration, 25, 31
 stripping, 31, 32
- panes, number, 18, 20, 49, 56
 repair, 40
 plate glass, 13
 projected windows, 22-23
 putty, 14, 25, 27, 40, 59
- Roof windows, 60
- Safety precautions, 25, 31
 sash jointing, 35, 36-37, 38
 sash (repair), 36-37
 screen, 8, 26, 31, 36, 56, 62
 sealing hook, 19
 shutters, 7, 17, 53
 insulating, 28, 54
 sill, 7, 19, 21, 25, 26, 27, 33, 35, 39, 41, 42, 57
 storm-windows, 19, 21, 23, 26, 45, 56-57
 storm shutters, 7, 17, 53
- Thermal value, 8, 26-27, 42-45, 50, 54, 56-57
 tilting windows, 22-23
- Ventilation, 8, 22-23, 51, 53, 56, 59
- Water infiltration, 8, 25-27, 35, 42, 51
 weatherstripping, 26, 41, 42-43, 51
 window models, traditional, 17-23
 new, 49-51
 wood, 10-11, 25, 27, 31-33, 35-39
 decay, 25, 35-39
 preservatives, 33, 35, 37

Bibliography

Books

- Argue, Robert and Marshall, Bziau
The super insulated retrofit book, Toronto, Renewable Energy In Canada, 1981.
- Barberot, Emile
Traite des constructions civiles, Paris, Librairie Polytechnique Ch. Béranger, 1924.
- Hanson, Shirley and Hubby, Nancy
Preserving and Maintaining the Older Home, New-York, N.-Y., McGraw-Hill, 1983.
- Hutchins, Nigel
Restoring Old Houses, Toronto, Van Nostrand Reinhold, 1983.
- Johnson, Ed
Old House Woodwork Restoration, Englewood Cliffs, N.J., Prentice Hall, 1983.
- Knight, Paul A.
Home retrofitting for energy saving, New-York, N.-Y., McGraw Hill, 1981.
- Léonidoff, Georges, Guindon, Vianney et Gagnon, Paul
Comment restaurer une maison traditionnelle, Quebec, Que., Ministry of Cultural Affairs, 1973.
- Litchfield, Michael
Renovation, A Complete Guide, Toronto, John Wiley & Sons Inc., 1982.
- Parks Canada, Quebec Region
Fenêtres traditionnelles, Unpublished Technical Document, 1979.
- Phillips, Morgan and Selwyn, Judith
Epoxyes for wood repairs in historic buildings, Washington, D.C., U.S. Government Printing Office, 1978.

Rempel, John I.
Building with Wood, Toronto, University of Toronto Press, 1980.

Shurcliff, William A.
Thermal Shutters and Shad, Andover, Mass., Brick House Publication Co., 1980.

The Editors of Time-Life Books
Home Repair and Improvement Doors and Windows, Alexandria, Va., Time-Life Books, 1978.

Periodicals

Note that other articles may have been published since this bibliography was compiled.

A.P.T. Bulletin,
 Ottawa, Association for Preservation Technology (A.P.T.)
Architectural Glass: History and Conservation, Vol. XIII, No 3, 1981.

Preservation Briefs,
 Washington, D.C., U.S. Government Printing Office

Myers, John H.
The repair of Historic Wooden Windows, No 9, 1980.

Weeks, Kay D. and Look, David
Exterior Paint Problems of Historic Woodwork, No 10, 1982.

The Old-House Journal,
 Brooklyn, N.-Y., The Old House Journal Corporation.

Wilson, Weber H.
Window Glass, Vol. VI, No 4, April 1978.

The Editors of the Old-House Journal,
Special Window Issue, Vol. X, No 4, April 1978.

Front cover picture:
Judy Oberlander

Other photographic
sources: Notman Photographic
Archives (McCord Museum,
McGill University), The
Heritage Canada Foundation,
Pierre Marier, Robert
Hébert, Martin Weaver, and
Heritage Montréal.

Printer:
MP Photo Reproductions Ltd.

Centre
S
HER (INTRO) 1987

**Technical guide 2
Traditional Windows**

How were traditional windows designed and made?

What are the most common problems and how can they be remedied?

How can old windows be kept in good condition?

How can rotten sills be replaced and loose sashes reinforced?

How can the energy efficiency of older windows be upgraded?

If it does become necessary to replace existing windows, how can new ones be chosen which work well and look right?

This guide provides answers to these questions and many others. It describes several simple repair techniques which can help you get decades of additional life out of your old windows.

In the same collection

1. Couvertures traditionnelles (in French)
 3. Traditional Masonry
-

Produced in cooperation with the Quebec Ministry of Cultural Affairs

The English language version of this guide was translated and adapted with the financial and technical support of the Heritage Canada Foundation.



The Heritage Canada Foundation